



VISTA PIVOT™
INSTALLATION GUIDE
Euro Pivot™ Impact Rated

MANUFACTURING

2200 Murphy Court
North Port, Florida 34289
888.989.3876 • 941.979.5316

888.989.EURO (3876)
www.euro-wall.com

SHOWROOM

1211 Stirling Road, Unit 102,
Dania Beach, Florida 33004

Finished floor must be installed prior to pivot door installation. However, if flooring is not able to be installed prior to pivot installation, a temporary substrate (wood bucking or starboard) can be utilized to install the pivot cup. The issue with not having the finished flooring installed is the panel will have to be removed when the finished flooring is installed to properly drill the bottom pivot cup. If your project has a sidelight with a mullion, leave the floor unfinished at the mullion clip location only, to allow for mullion clip to be properly secured and installed before being covered by the finished floor.

Important

Before beginning the install, read the instructions in their entirety. Perform install using the recommended methods contained within this guide. Deviating from recommended install procedures could impair functionality and could void any warranty.

Caution

It is the obligation of the building owner, contractor, architect or installer to ensure that door systems being installed comply with all building codes and regulations pertaining to the install location. Euro-Wall Systems, Inc. assumes no responsibility for failure to meet applicable laws, ordinances, building codes, etc.

Description of Supplied Parts

Upon delivery please inspect for any noticeable damage and check supplied materials with included packing list. If there is any damage and / or any missing components, please contact Euro-Wall as soon as possible. For installs with multiple opening units, do not mix and match any components even if the units are the same dimensions.

Protection of Unit During Construction

It is important that during the construction phase the door system components are protected and covered in a clean dry location away from any factors that could cause damage. Door systems that are stored during the construction phase can often times be exposed to situations that can cause permanent damage such as cement splatter, tar, paint, weld spray, falling objects, construction dust, sandblasting, etc. After installation of the door system is completed and construction is still

being performed, ensure that the large opening where the door system is installed does not become a major in and out access point for contractors and subcontractors. Damage done during the construction phase can be irreparable and can cause significant setbacks with new panels needing to be constructed.

Panel Protective Film

If your project comes with protective film, remove all protective film from panels, frames and any other metal extrusion within 30 days of job delivery. Failure to do so could cause finish damage voiding the product warranty.

Considerations Before You Get Started

Space: Make sure there is an appropriate amount of working space in and around the install opening. It is best practice to assemble the frame on top of saw horses (using at least four, one for each corner), therefore, make sure there is adequate room to assemble the frame in the area around the opening. Additionally, leave plenty of room without clutter to maneuver panels during install.

Power: Ideally power should be connected and accessible for tool operation and to ensure optimal lighting conditions for the install.

Moving Panels: Never “walk panels” and never try to move panels with only one person. Always lift and move panels by hand or using glass suction cups using at least two people. For installs less than 8’ in height, use a minimum of two installers. For panels over 8’ tall, a team of four is recommend for the install.

A. Tools Required

Step A.1 - Tools Checklist

Please make sure you have all of the required tools listed below before performing the install.

- ✓ Copy of install guide
- ✓ Screw guns and chargers
- ✓ Extension bits Phillips #2 / #3 for tapcons
- ✓ Drill bits for steel, concrete and wood
- ✓ 3/4" drill bit
- ✓ 3/8" and 1/4" drill bits
- ✓ Hand screwdrivers (Phillips #2 and #3)
- ✓ Rubber mallet
- ✓ SDS drill
- ✓ Laser level
- ✓ Dot / plumb laser level
- ✓ 2', 4' and 6' levels
- ✓ Pencil
- ✓ Chalk line
- ✓ String line (for measuring square)
- ✓ File
- ✓ Pliers
- ✓ Channel locks
- ✓ Snips
- ✓ Utility knife
- ✓ Saw horses (min 4)
- ✓ Glass cups for moving panels (min 4)
- ✓ Shop-Vac
- ✓ Broom / dustpan
- ✓ Garbage can / garbage bags
- ✓ 5mm allen key
- ✓ Protective eyewear

Step A.2 - Disposables Checklist

Please make sure you have all of the required tools listed below before performing the install.

- ✓ Tapcons (if drilling into concrete)
- ✓ Screws for installing frame into substrate (supplied)
- ✓ Caulk / sealant
- ✓ Lubricant / wax
- ✓ Shims
- ✓ Backer rod
- ✓ Sill pan (width of the opening plus extra for play)
- ✓ Windex / glass cleaner
- ✓ Clean rags
- ✓ Paper towels
- ✓ Cardboard / moving blankets
- ✓ Four 2x4's for panel installation

Step A.3 - Labor Checklist

Please make sure you have the adequate number of installers

- ✓ For installations with panels under 8 feet, recommended minimum of 2 installers
- ✓ For installations with panels over 8 feet, recommended minimum of 4 installers

B. Parts / Pieces Included

Below you will find a summary of the parts and pieces that are included with the door system. For a comprehensive checklist please see the packing list included with your order.

Step B.1 - Frame Checklist

Jambs (2) (See Figure B.1)

Header (1) (See Figure B.1)

Frame weatherstripping (See Figure B.2)

FIGURE B.1: JAMBS & HEADER

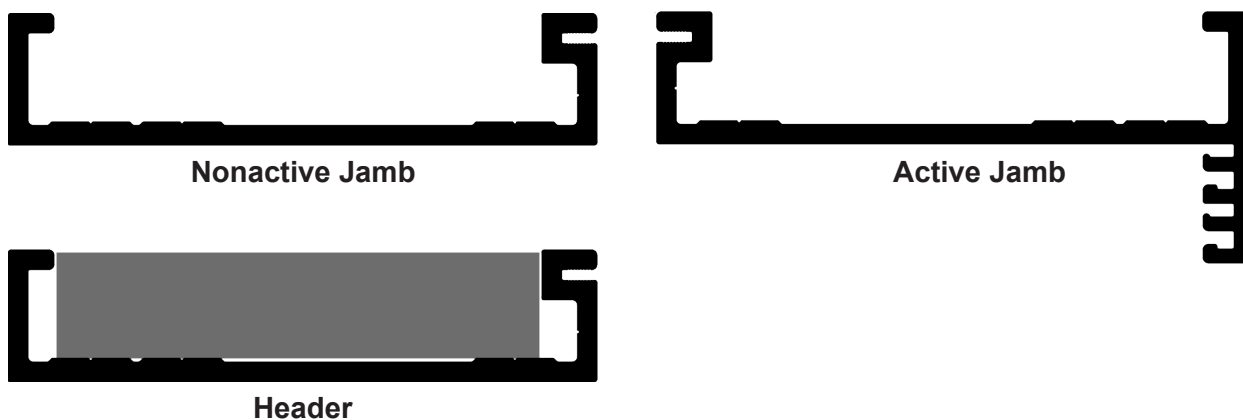

Step B.2 - Panel Checklist

Each system comes with a designated hardware box for each panel allocated in the work order. Each door panel must be installed using the corresponding hardware box.

- ✓ Panels (number designated by work order)
- ✓ Panel weatherstripping small - see **Figure B.1** to distinguish between the two different weatherstripping types
- ✓ Panel weatherstripping large - see **Figure B.1** to distinguish between the two different weatherstripping types

FIGURE B.2: PANEL WEATHERSTRIPPING PROFILES



Step B.3 - Hardware / Handles Checklist

NOTE:

The hardware included with your install package will vary depending on the install configuration. Please check your parts packing list for the hardware specifications for this installation.



25N325ATF
Anchor Screw
All screws for jambs and header are provided

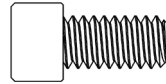

6C12KCSS/D912
Set Screw
Quantity varies



DBHL-04
Removable Twin Point Lever
Quantity: 1

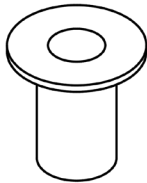

P227
Shootbolt / Pivot Cups
Ladder Pull - Quantity: 5
Multipoint Handle - Quantity: 3

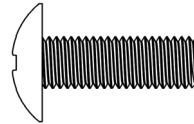

25C75MPTS
Frame Screw
Quantity varies



62MP0500N
1/2" Hole Plugs
Quantity varies

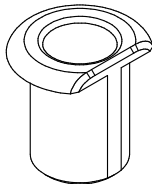

C0077-A TP Socket
Modified Shootbolt Cups
Panel w/ Ladder Pull - Quantity: 0
Panel w/ Multipoint Handle - Quantity: 2

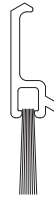

NGP-673
Door Sweep
Quantity: 4

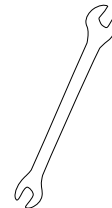

11850-1415
14mm/15mm Wrench
Quantity: 1



CP-0039-A
Top Pivot Pin
Quantity: 1



CP-0038-A
Bottom Pivot Pin
Quantity: 1

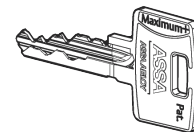

Matching Key to Cylinder Lock
Quantity: 2

C. Opening Preparation

Step C.1 - Measure, Level, Square & Clean

Measure opening at at least 3 points (See Figure C.1) to check for plumb, square and level of the opening

- ✓ Vacuum / sweep opening to be clear of dust / dirt / debris

- ✓ Ensure that there is less than 3/16" max deflection at the header

FIGURE C1: MEASURING THE OPENING

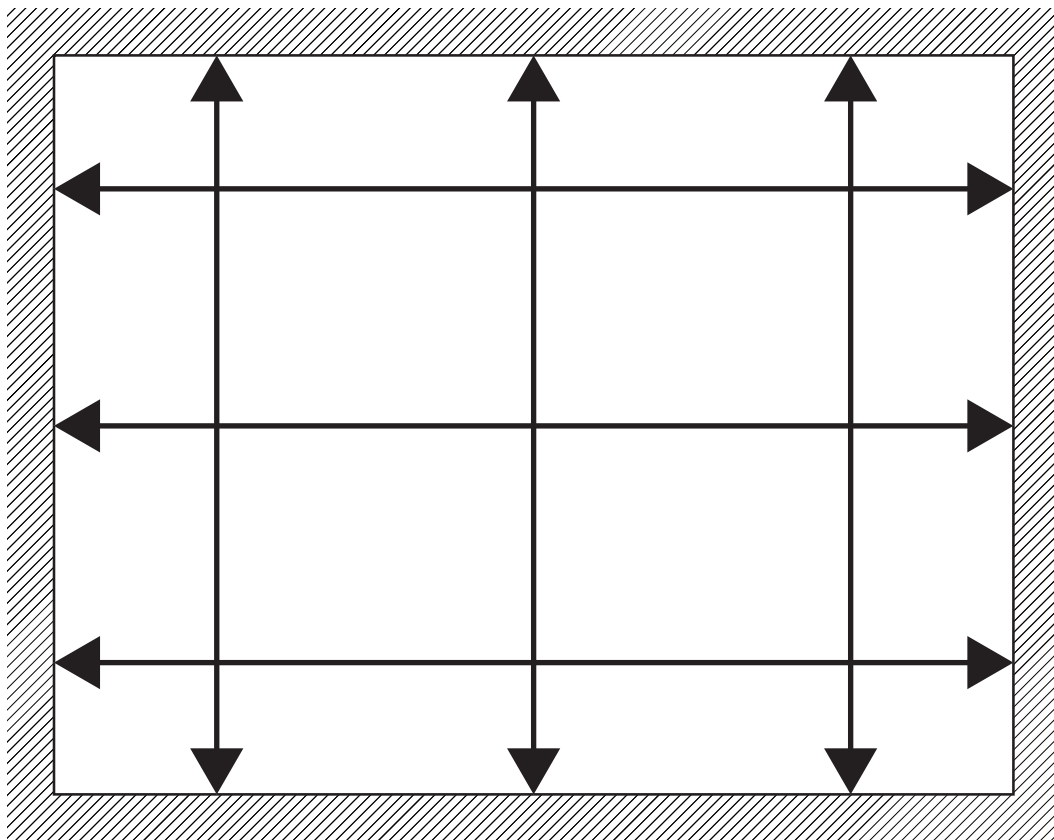

QR CODE: VIEW VIDEO INSTRUCTIONS ON MEASURING THE OPENING



Step C.2 - Swing Orientations

**Right Hand
Outswing**

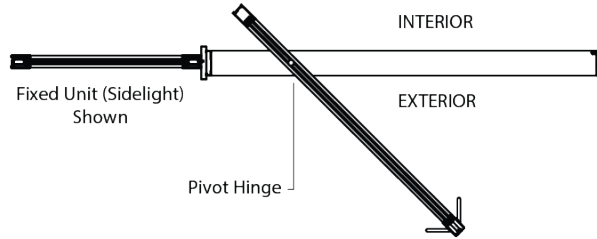

Jamb Orientation



**Left Hand
Inswing**

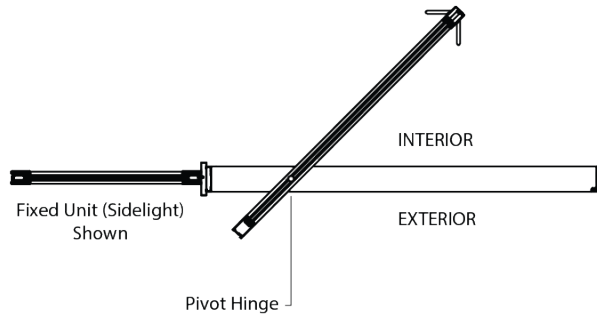

**Left Hand
Outswing**

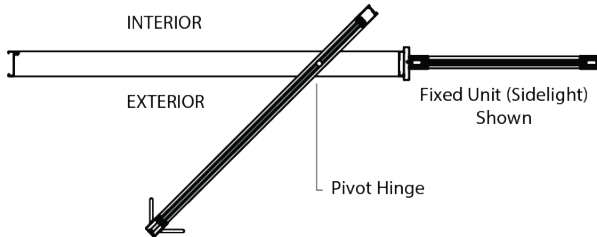

**Right Hand
Inswing**

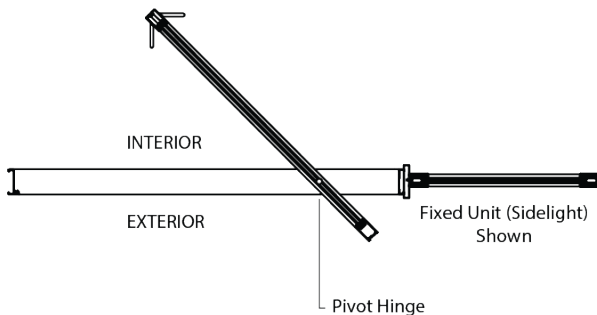

D. Frame Assembly

Step D.1 - Connect Jambs to Header

Place the frame as it will be assembled on 4 sawhorses near the opening. Sawhorses should be padded / wrapped to protect the frame from scratches or damage. DO NOT ASSEMBLE FRAME ON THE GROUND. Line the top of the jamb edge with silicone. Turn the header and jamb on their sides to connect them. Install two frame screws (provided) on each jamb to connect to header.

QR CODE: FRAME ASSEMBLY



Step D.2 - Strike Plate Box

For the pivot door to latch into the jamb it uses a provided strike plate. On the back of the strike plate there is a strike plate box. If the strike plate is used, notch the substrate that the jamb is attaching to. The strike plate box is only for aesthetics. It creates a dark cavity for the hook to go into and does not have to be used, as it is not structural.

QR CODE: STRIKE PLATE BOX

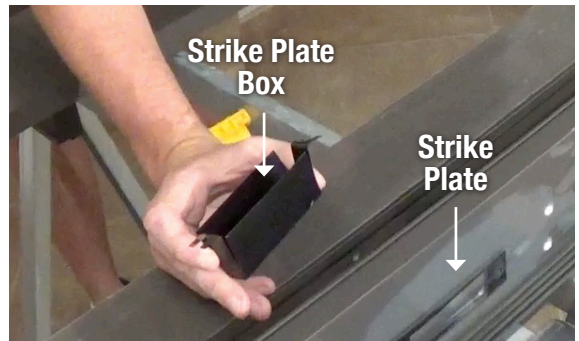

Note: The process for notching for the strike plate box will depend on the substrate.

QR CODE: NOTCH STRIKE PLATE BOX



**CONFIGURATION:
LADDER PULL W/ A RIGHT HAND OUTSWING
A-E DENOTES SHOOTBOLT CUP LOCATIONS**

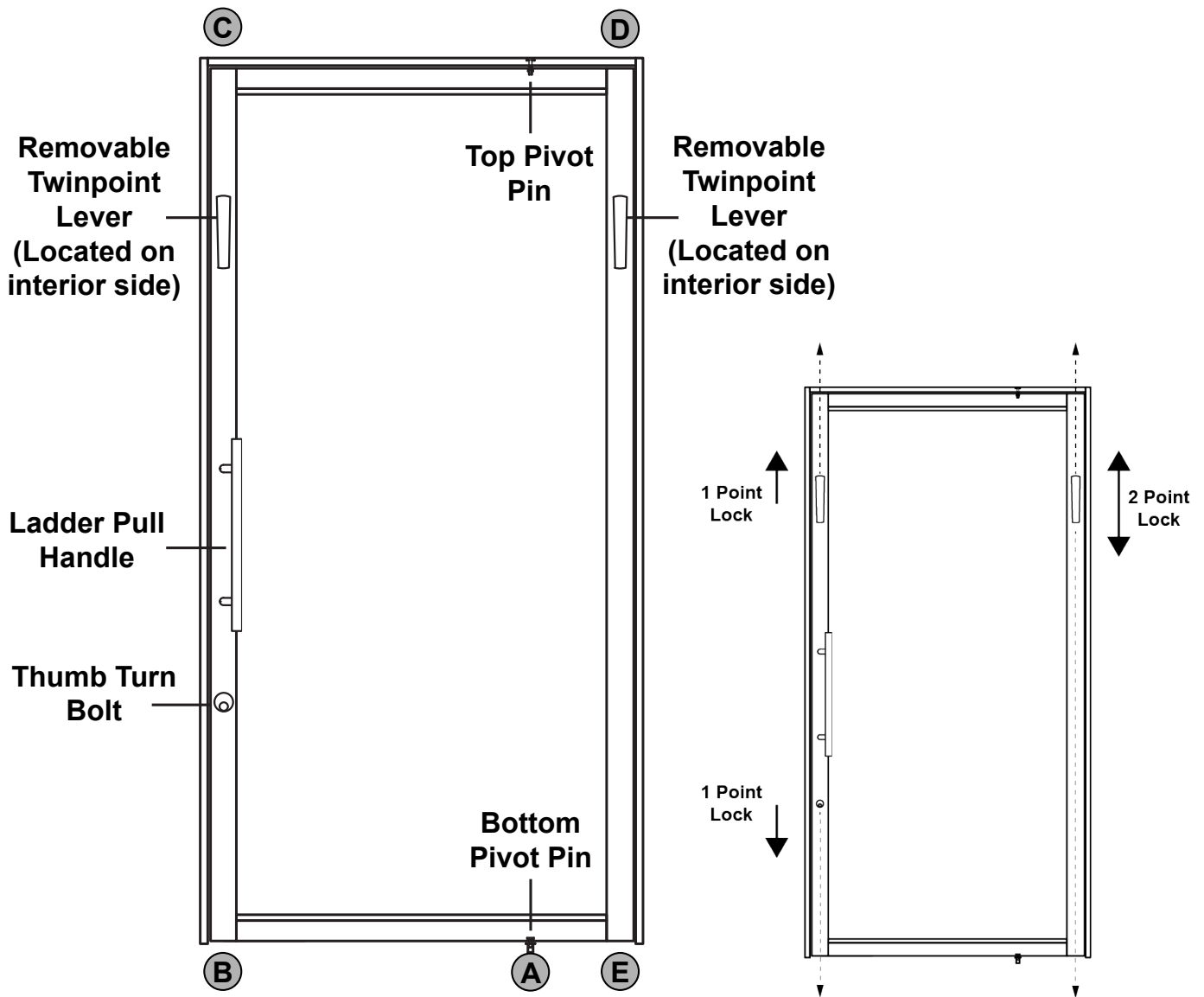

(EXTERIOR VIEW)

**CONFIGURATION:
MULTIPOINT W/ A RIGHT HAND OUTSWING
A-E DENOTES SHOOTBOLT CUP LOCATIONS**

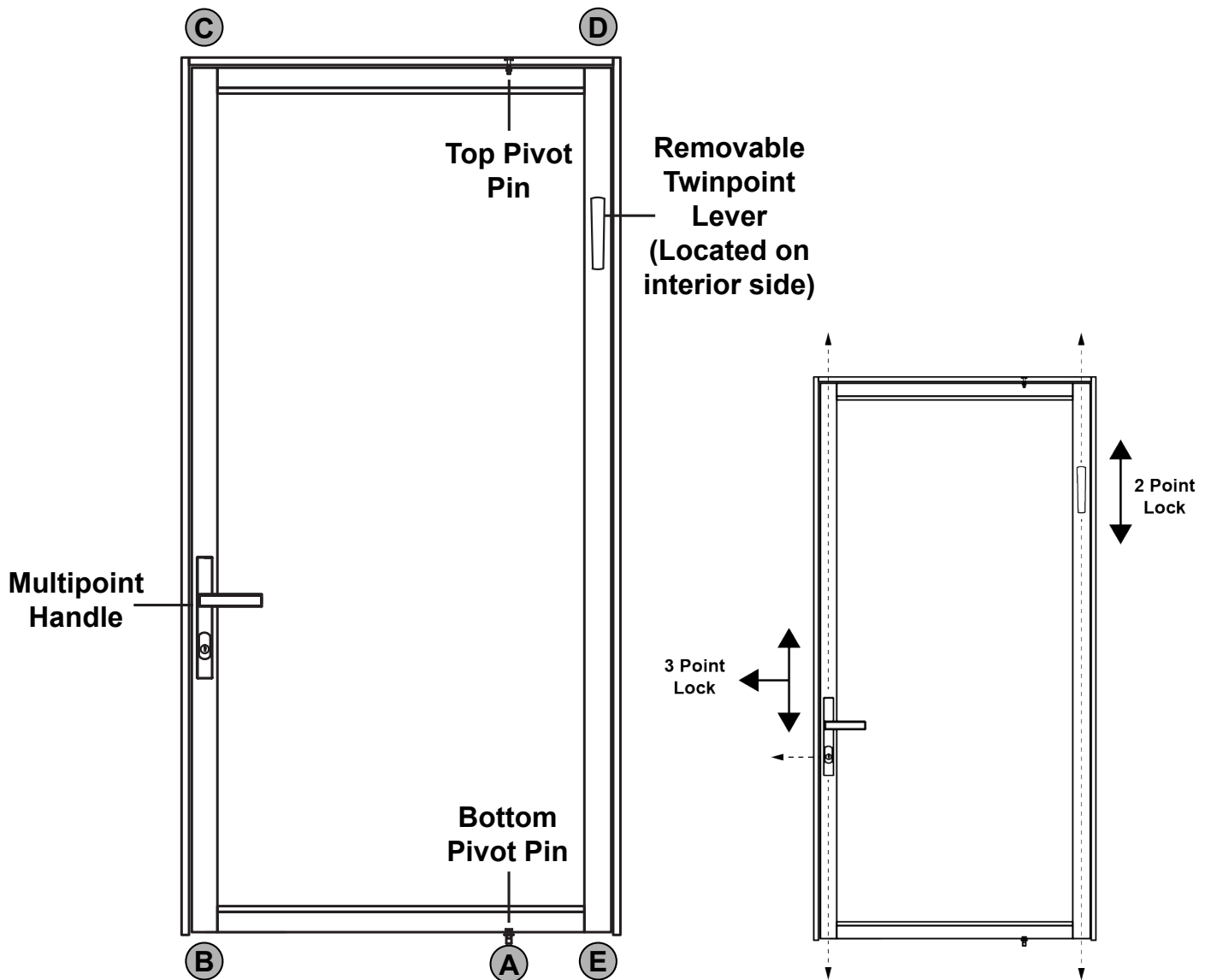

(EXTERIOR VIEW)

E. Dry Fit Frame

Step E.1 - Mark Top Pivot Pin Location

Move the frame into the opening. Check the jambs and header to make sure they are plumb, square and level. Reveal should be equal on both sides of the header. Mark the top pivot pin location. Remove frame from opening.

**QR CODE: DRY FIT
FRAME & MARK TOP
PIVOT PIN LOCATION**



Note: The video refers to dry fitting the frame next to a transom, however if the configuration doesn't have a transom these steps are the same with any substrate.



F. Drill Top Pivot Pin Location

Step F.1 - Drill Top Pivot Pin Location

With any drilling done, make sure the appropriate PPE is used. Start by predrilling the top pivot pin location with a 3/16" bit. Then move up to using a 1" bit. The type of bit that used is dependant upon the substrate. (If the substrate is wood, use a 1" wood bit. If the substrate is steel, use a 1" steel bit. If the substrate is concrete, use a 1" SDS bit.) After the 1" hole is drilled, verify that the top pivot pin fits all the way flush into the hole. When the panel is moved into the opening, the pivot pin will be installed in the header and will need to be pushed up into this hole.

**QR CODE: DRILL TOP
PIVOT PIN LOCATION**



G. Install Frame

Step G.1 - Install Top Pivot Pin

Place the top pivot pin into the header. Move the frame into the opening. Once the frame is in the correct spot, the pivot pin should easily push up into the drilled hole.

QR CODE: INSTALL
TOP PIVOT PIN



Step G.2 - Attach Frame to Opening

Square, level and plumb the frame to the substrate. Pre-drill in all the locations (for all substrate conditions) along the jambs and header using a 3/16" drill bit. Install 1/4" screws (supplied) in all the predrilled locations, connecting the pivot jambs and header to the substrate.

QR CODE: ATTACH
FRAME TO OPENING



Note: The video refers to attaching the frame to a transom, however if the configuration doesn't have a transom these steps are the same with any substrate.

H. Install Pivot Pin Cup A

Step H.1 - Mark Pivot Pin Cup A Location

Make sure the top pivot pin is hanging straight down. Plumb using a dot/plumb laser level, mark the bottom pivot pin location using the top pivot bolt as the reference point. Take a 3/4" bit and place it on the ground where the laser is pointing to. Trace around the bit with a pencil to mark the drill location for pivot cup A.

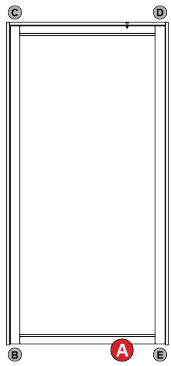
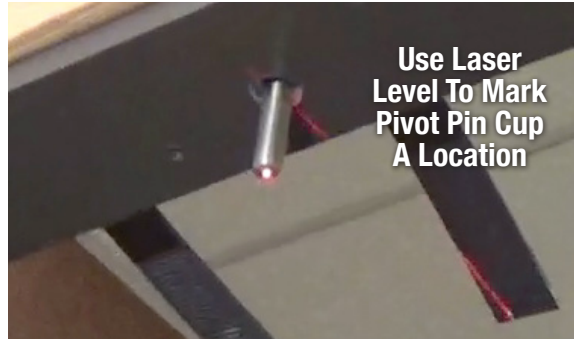

QR CODE:
MARK PIVOT
PIN CUP A
LOCATION



Step H.2 - Drill Pivot Pin Cup A Location

Using a 3/4" drill bit, drill out the bottom pivot pin cup A location to a depth of 1-1/4". The type of 3/4" drill bit used is dependent on the substrate.

QR CODE: DRILL PIVOT PIN
CUP A LOCATION



Step H.3 - Install Pivot Pin Cup A

Check to verify that the pivot cup sits flush into the drilled hole. Predrill out pivot pin cup A location with a 3/16" SDS. Secure pivot pin cup A with 1/4" tapcon screw.

QR CODE: INSTALL BOTTOM
PIVOT PIN CUP A



I. Install Panel

Step I.1 - Secure Top Pivot Pin

Before placing the panel in the opening, use blue tape to push the top pivot pin up into the header to keep it out of the way as the panel is installed.

QR CODE: SECURE TOP PIVOT PIN



Step I.2 - Preparation for Panel Install

Place 2x4's or other wood that is at least 1-1/2" thick by the opening for the panel to rest on. The bottom pivot pin sticks out a little over 1". The bottom pivot pin should never make contact with the ground; this could damage the pin and/or the panel.

QR CODE: PREPARATION FOR PANEL INSTALL



Step I.3 - Move Panel Onto Wood

Use a minimum of 4 people to move the panel onto the pieces of wood. Do not let the bottom pivot pin come in contact with the ground. Once in place, push the panel into the upright position.

QR CODE: MOVE PANEL ONTO WOOD



Step I.4 - Insert Bottom Pivot Pin

Attach glass cups onto the panel. Lift panel up and guide the bottom pivot pin into the bottom pivot pin cup.

QR CODE: INSERT BOTTOM PIVOT PIN INTO LOCATION A



Step I.5 - Shim the Panel

Shim the bottom of the panel so you have equal gapping between the panel - header and the panel - floor. Make sure the top pivot is aligned with the pivot location on the panel.

QR CODE: SHIM THE PANEL



Step I.6 - Securing the Panel

Remove the 5mm allen set screw on the interior of the top rail and remove the blue tape covering the top pivot pin. The top pivot pin should fall into place into the top rail. Use a double ended 14mm/15mm wrench to thread top pivot pin into panel. Use the 15mm end of the wrench for the first half of threading the pivot pin. Use the 14mm end of the wrench for threading the second half of the pivot pin. (See Figure I.6) Continue to thread until there is an even 3/8" gap at the top and bottom of the panel. Use the allen key to secure/tighten the 5mm allen set screw into the panel on the flat side of top pivot pin.

QR CODE: SECURING THE PANEL



FIGURE I.6

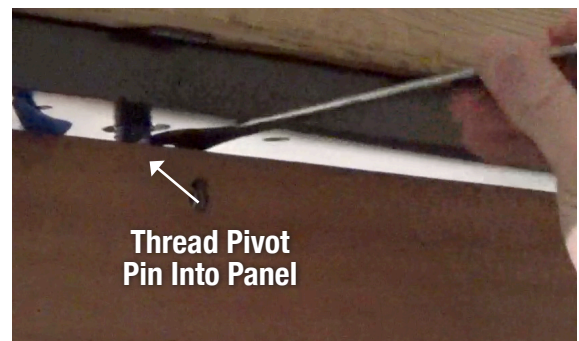
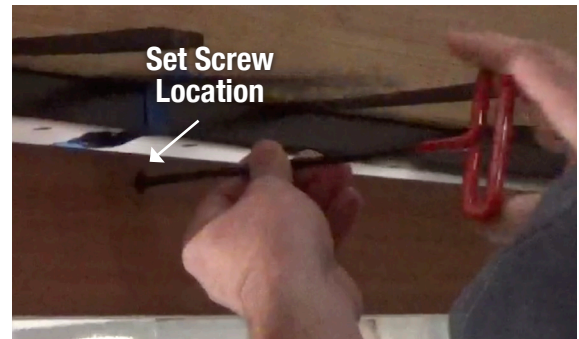
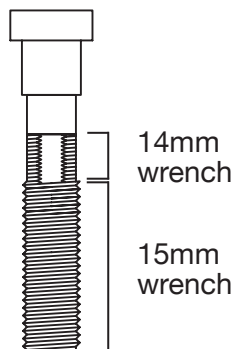

Step I.7 - Test Opening Panel

Test operation by slowly opening the panel to make sure there's no rubbing issues on any side of the panel.

QR CODE: TEST OPENING PANEL

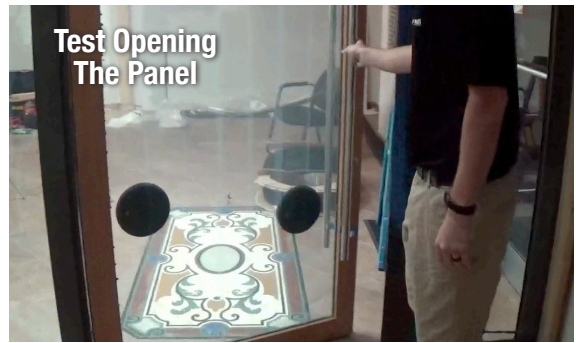

J. Frame Weatherstripping

Step J.1 - Install Frame Weatherstripping

Install frame weatherstripping on the jamb with the riser. The door needs to have the correct spacing before installing the bottom shootbolt cup. The weatherstripping pushes into the groove all the way down the jamb.

QR CODE: INSTALL FRAME WEATHERSTRIPPING



K. Install Shootbolt Cup B

Step K.1 - Mark Shootbolt Cup B Location

(See Figure E.1) Place several layers of blue tape on the flooring substrate at the shootbolt B location. Close the door, compress it against the jamb and make sure the latch from the thumb bolt/multipoint handle (See Figure K.1) lines up with strike plate. Lock and unlock the door several times to engage the shootbolt leaving an indent in the blue tape, marking the spot for the shootbolt B cup.

QR CODE:
MARK
SHOOTBOLT
CUP B
LOCATION

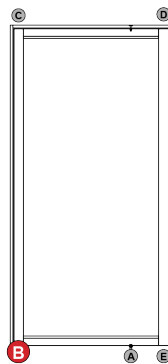

Exterior View

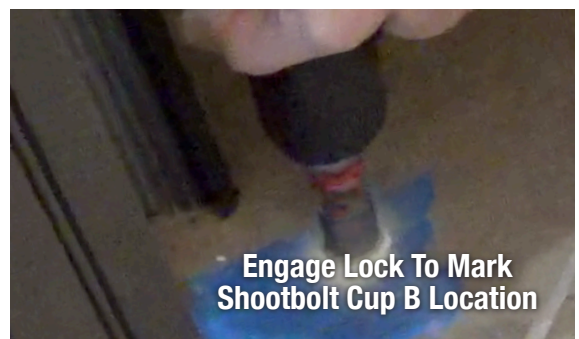

FIGURED K.1: MULTIPOINT HANDLE OPERATION INSTRUCTIONS

Unlock: To unlock and open, turn the thumb bolt (if applicable) to the unlock position until it cannot rotate any further and turn the handle fully down - this will disengage the multipoint lock, allowing the door to open.

Lock: Prior to engaging the thumb bolt (if applicable), turn the handle up roughly 45° (see illustration below) to engage the locking points. After the locking mechanism is engaged, release the handle and let it move back down to the normal position. Lock the thumb bolt lock by rotating it until locked and cannot rotate any further (if applicable).

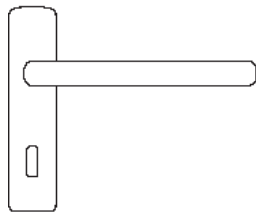

Normal Position

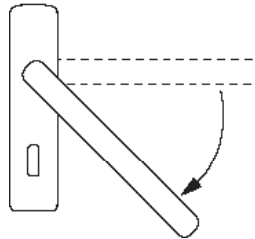

Unlocking

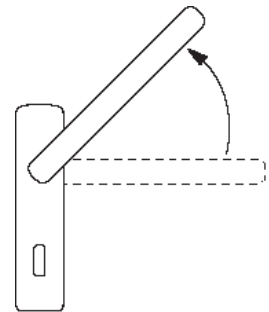

Engaging / Locking

**QR CODE: MULTIPOINT
HANDLE OPERATION**

**Step K.2 - Drill Shootbolt Cup B Location**

Drill out the shootbolt cup B location where the blue tape is indented using a 3/4" appropriate substrate bit.



Step K.3 - Install Shootbolt Cup B

Insert the shootbolt cup into the drilled hole. Drill out the shootbolt cup B with 3/16" SDS and anchor in place using a 1/4" tapcon screw.



Shootbolt / Pivot Cup

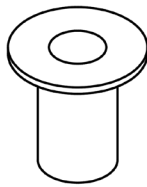

This cup will be used for cups B & C if your door has a ladder pull handle.

Modified Shootbolt Cup

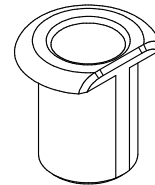

This cup will be used for cups B & C if your door has a multipoint handle.

Step K.4 - Test Shootbolt Cup B

Close the door and turn the thumb bolt lock or multipoint handle lock to engage the shootbolt. Test to ensure the shootbolt goes into shootbolt cup B.

QR CODE: TEST SHOOTBOLT CUP B



L. Panel Weatherstripping

Step L.1 - Install Panel Weatherstripping

There will be two types of panel weatherstripping that are different sizes. Choose the appropriate size panel weatherstripping based on the gap around the frame. If there is an 1/8" gap use "small p", if there is a 1/4" gap use "large p". When the door closes the weatherstripping should compress securely. The weatherstripping pushes into the groove along the jamb.



Panel Weatherstripping Large
"Large P Weatherstripping"



Panel Weatherstripping Small
"Small P Weatherstripping"

QR CODE: INSTALL PANEL WEATHERSTRIPPING

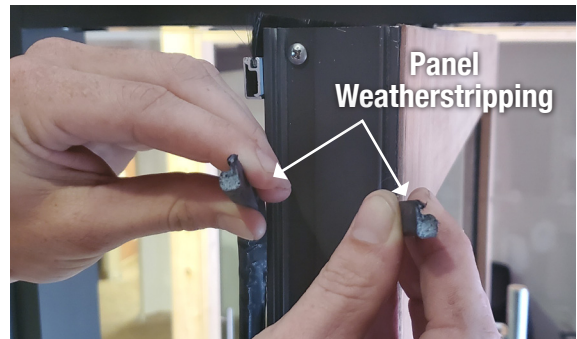

M. Install Shootbolt Cup C

Step M.1 - Mark Shootbolt Cup C Location

(See Figure E.1) Place several layer of blue tape on the shootbolt cup C location. If your door has a ladder pull handle, engage the removable twinpoint lever several times to make indents in the blue tape, marking the shootbolt cup C location. Insert the removable twinpoint lever horizontally then turn it to engage it. (See Step P) If your door has a multipoint handle, engage the the handle several times to make indents in the blue tape, marking the shootbolt cup C location. (See Figure K.1)

QR CODE:
MARK
SHOOTBOLT
CUP C
LOCATION

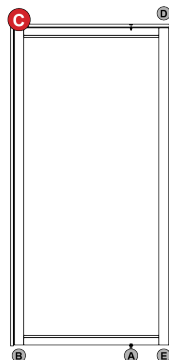

Exterior View



Step M.2 - Drill Shootbolt Cup C Location

Drill out the shootbolt cup C location where the blue tape is indented. Start using a 1/4" bit, then a 1/2" bit and work up to using a 3/4" steel bit. Use an appropriate bit for the substrate for the rest of the header.



Step M.3 - Install Shootbolt Cup C

Insert the shootbolt cup into the drilled hole. Use the appropriate screw for the substrate. If drilling into concrete, predrill the shootbolt cup 1/4" to accommodate the tapcon. Drill out the shootbolt cup C with 3/16" SDS and screw in a 1/4" tapcon screw.



Step M.4 - Test Shootbolt Cup C

Close the door and test to make sure the shootbolt goes into the shootbolt cup C.

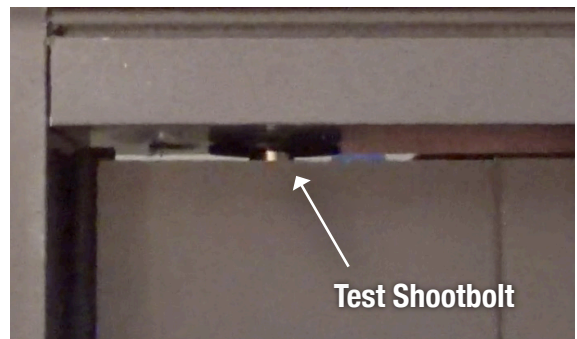

N. Install Shootbolt Cup D

Step N.1 - Mark, Drill & Install Shootbolt Cup D

(See Figure E.1) Repeat steps M.1-M.4 for the installation of shootbolt cup D. Insert and engage the removable twinpoint lever to make the indents on the blue tape. Insert the removable twinpoint lever horizontally then turn it 90° clockwise to engage it. (See Step P)



QR CODE:
INSTALL
SHOOTBOLT
CUP D

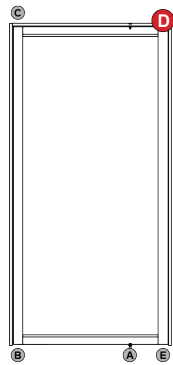

Exterior View

O. Install Shootbolt Cup E

Step O.1 - Mark, Drill & Install Shootbolt Cup E

(See Figure E.1) Repeat steps K.1-K.4 for the installation of shootbolt cup E. Insert and engage the removable twinpoint lever to make the indents on the blue tape. Insert the removable twinpoint lever horizontally then turn it 90° clockwise to engage it. (See Step P)



QR CODE:
INSTALL
SHOOTBOLT
CUP E

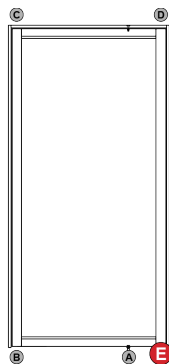

Exterior View

P. Removable Twinpoint Lever

Step P.1 - Removable Twinpoint Lever Usage

Twinpoint levers are used during inclement weather and offer the security of a top and bottom locking shootbolt. Remove the two plugs on the interior side of the panel located near the top of the stiles. To engage and lock the twinpoints make sure the lever is turned completely down into the locked position. The configuration will determine which direction the twinpoint lever must turn to unlock. To disengage and unlock the twinpoint turn the lever roughly 90°, towards the center of the panel.



QR CODE: REMOVABLE TWINPOINT LEVER

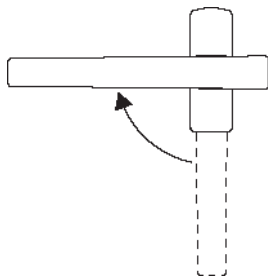

Unlocked Position

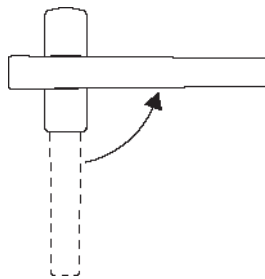

Unlocked Position



Locked Position

Q. Sweeps

Step Q.1 - Prepare Sweeps for Install

Make sure the door is closed and locked when measuring for sweep installation. Measure from the gaps between the panel and frame to calculate the length of the sweeps. Remove the brushes from the sweeps, use a chop saw to cut the sweeps down to the appropriate size. Use tin snips to cut the brush. Reinsert the brush back into the sweep.



QR CODE: PREPARE SWEEPS FOR INSTALL

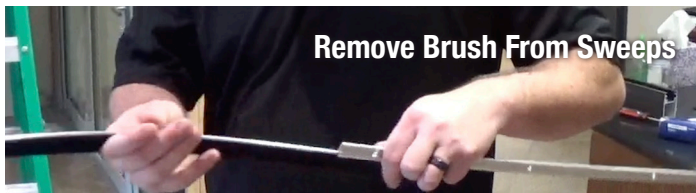

Step Q.2 - Install Sweeps

Check to make sure the sweeps are cut to the correct size. Place sweeps against the panel and position to where the sweep is slightly compressed. Predrill through the provided holes of the sweeps or at the locations chosen. Cut the sweep cover down to the appropriate size. Then attach the sweep cover by tapping along the whole sweep with a rubber mallet. Repeat these steps to install the exterior bottom and interior sweeps.

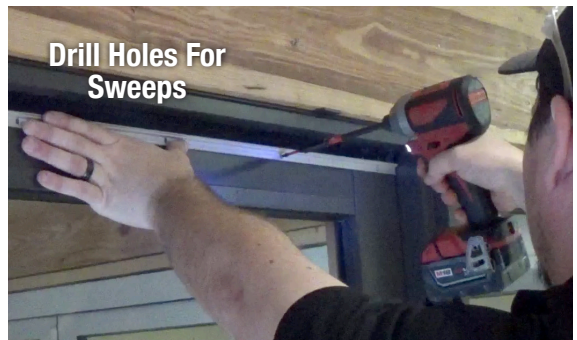

QR CODE: INSTALL SWEEPS



R. Water Drainage System

Step R.1 - Drain Installation

Install drain on interior of the panel location making sure to align the center of the drainage channel to the inside edge of the panel. Ensure there are no kinks in the drain tube to allow for clear flow of water drainage. Make sure drainage tube flows to an adequate location away from the door location. In certain cases additional drainage tube may be needed based upon the drain location.

FIGURE R.1

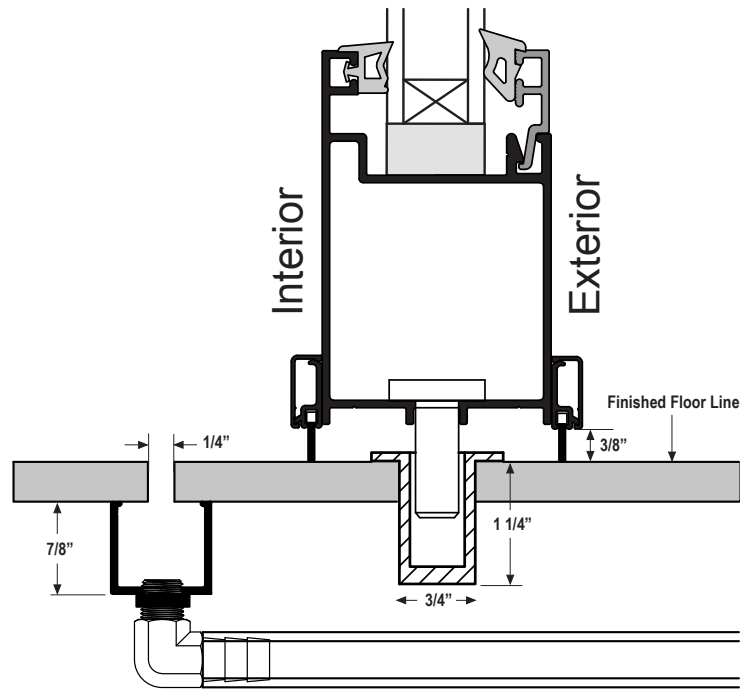

Step R.2 - Secure Channel

Secure the channel with the appropriate anchors for your substrate and allow for tile (or other floor covering) to cover the channel while leaving a 1/4" gap to allow the water to pass into the drainage system. Seal all screw penetrations and end of the channel with sealant.

Step R.3 - Test Drainage System

Test drainage system to verify there are no leaks.

S. Maintenance & Care

Panel Protective Film

If your project comes with protective film, remove all protective film from panels, frames and any other metal extrusion within 30 days of job delivery. Failure to do so could cause finish damage voiding the product warranty.

Hinges

Wipe down the visible surfaces with warm soapy water on a soft cloth and then rinse off by wiping with a clean damp cloth.

Locks and Hardware

Wipe down the visible surfaces with warm soapy water on a soft cloth and then rinse off by wiping with a clean damp cloth. Spray a thin film of light machine oil or one of the corrosion preventative sprays such as CRC Marine 66®, Innox® or CorrosionX®. Be careful to avoid getting these compounds on wood or fiberglass panels or jambs as they may cause staining. Be sure to wipe down any overspray.

Track and Bearings

Apply white petroleum jelly (Vaseline) or equivalent, to inner lip of each side of head track with a clean cloth. Distribute lubricant evenly along track. Ensure wheels and bearings receive sufficient lubricant. Wipe all contaminant from track surfaces with damp cloth and mild detergent, clean surfaces with clean soft cloth. Apply thin film for systems installed in severe environments by wiping surfaces of track with anti-corrosive substance, such as, CRC Marine 66®, Innox® or CorrosionX®.

Hangers, Pivots and Brackets

Before applying anti-corrosive substance, wipe exposed surfaces with clean soft cloth soaked in warm soapy water; then rinse, clean and dry. Spray thin film to hangers, pivots and brackets with anti-corrosive substance, such as, CRC Marine 66®, Innox® or CorrosionX®.

Frequency

Regular maintenance is required for all hardware, even stainless steel, to keep manufacturer's warranty in place. Failure to provide proof of maintenance will void any warranty.

Carry out maintenance procedures with the following minimum recommendations:

- General environments - every 3 months
- Marine, industrial environments, within 5 miles of a body of water and / or a pool area - every month.

Inclement Weather

Twinpoint levers are used during inclement weather and offer the security of a top and bottom locking shootbolt. Remove the two plugs on the interior side of the panel located near the top of the stiles. To engage and lock the twinpoints make sure the lever is turned completely down into the locked position. The configuration will determine which direction the twinpoint lever must turn to unlock. To disengage and unlock the twinpoint turn the lever roughly 90°, towards the center of the panel.

QR CODE: REMOVABLE TWINPOINT LEVER



NOTE: Maintenance is required to extend the life of your door system and to maintain the Euro-Wall Warranty