



VISTA MULTI SLIDE™
INSTALL GUIDE
Vista Multi Slide™ Impact Rated

MANUFACTURING

2200 Murphy Court
North Port, Florida 34289
888.989.3876 • 941.979.5316

888.989.EURO (3876)
www.euro-wall.com

SHOWROOM

1211 Stirling Road, Unit 102,
Dania Beach, Florida 33004

Important

Before beginning the install, read the instructions in their entirety. Perform install using the recommended methods contained within this guide. Deviating from recommended install procedures could impair functionality and could void any warranty.

Caution

It is the obligation of the building owner, contractor, architect or installer to ensure that door systems being installed comply with all building codes and regulations pertaining to the install location. Euro-Wall Systems, Inc. assumes no responsibility for failure to meet applicable laws, ordinances, building codes, etc.

Description of Supplied Parts

Upon delivery please inspect for any noticeable damage and check supplied materials with included packing list. If there is any damage and / or any missing components, please contact Euro-Wall as soon as possible. For installs with multiple opening units, do not mix and match any components even if the units are the same dimensions.

Protection of Unit During Construction

It is important that during the construction phase the door system components are protected and covered in a clean dry location away from any factors that could cause damage. Door systems that are stored during the construction phase can often times be exposed to situations that can cause permanent damage such as cement splatter, tar, paint, weld spray, falling objects, construction dust, sandblasting, etc. After installation of the door system is completed and construction is still being performed, ensure that the large opening where the door system is installed does not become a major in and out access point for contractors and subcontractors. Damage done during the construction phase can be irreparable and can cause significant setbacks with new panels needing to be constructed.

Panel Protective Film

If your project comes with protective film, remove all protective film from panels, frames and any other metal extrusion within 30 days of job delivery. Failure to do so could cause finish damage voiding the product warranty.

Considerations Before You Get Started

Space: Make sure you have the appropriate working space in and around the install opening. It is best practice to assemble the frame on top of saw horses (using at least four, one for each corner), therefore, make sure you have adequate room to assemble the frame in the area around the opening. Additionally, leave plenty of room without clutter to maneuver panels during install.

Power: Ideally power should be connected and accessible for tool operation and to ensure optimal lighting conditions for the install.

Moving Panels: Never “walk panels” and never try to move panels with only one person. Always lift and move panels by hand or using glass suction cups using at least two people. For installs less than 8’ in height, use a minimum of two installers. For panels over 8’ tall, a team of four is recommend for the install.

A. Tools Required

Step A.1 - Tools Checklist

Please make sure you have all of the required tools listed below before performing the install.

- ✓ Screw guns and chargers
- ✓ Extension bits Phillips #2 / #3 for tapcons
- ✓ Drill bits for steel, concrete and wood
- ✓ 3/4" drill bit
- ✓ 3/8" and 1/4" drill bits
- ✓ Hand screwdrivers (Phillips #2 and #3)
- ✓ 2.5mm allen key
- ✓ 4mm allen key
- ✓ 6mm allen key
- ✓ Rubber mallet
- ✓ SDS gun
- ✓ Laser level
- ✓ 2', 4' and 6' levels
- ✓ Pencil
- ✓ Chalk line
- ✓ String line (for measuring square)
- ✓ File
- ✓ Pliers
- ✓ Channel locks
- ✓ Snips
- ✓ Utility knife
- ✓ Saw horses (min 4)
- ✓ Glass cups for moving panels (min 4)
- ✓ Shop-Vac
- ✓ Broom / dustpan
- ✓ Garbage can / garbage bags
- ✓ Copy of install guide

Step A.2 - Disposables Checklist

Please make sure you have all of the required tools listed below before performing the install.

- ✓ Tapcons (if drilling into concrete)
- ✓ Screws for installing frame into substrate
- ✓ Caulk / sealant
- ✓ Lubricant / wax
- ✓ Shims
- ✓ Backer rod
- ✓ Sill pan (width of the opening plus extra for play)
- ✓ Windex / glass cleaner
- ✓ Clean rags
- ✓ Paper towels
- ✓ Cardboard / moving blankets

Step A.3 - Labor Checklist

Please make sure you have the adequate number of installers

- ✓ For installations with panels under 8 feet, recommended minimum of 2 installers
- ✓ For installations with panels over 8 feet, recommended minimum of 4 installers

B. Parts / Pieces Included

Below you will find a summary of the parts and pieces that are included with the door system. For a comprehensive checklist please see the packing list included with your order.

Step B.1 - Frame Checklist

- ✓ Jamb Track (2)
- ✓ Header Track (1)
- ✓ Sill Track (1) - 2 track, 3 track, 4 track or 5 track option. See **Figure B.1** below to identify the type used for this install
- ✓ Snap Track See **Figure B.2**
- ✓ Header / Jamb Trim See **Figure B.2**
- ✓ Screw caps
- ✓ Frame corner keys (8) See **Figure B.2**
- ✓ Adjustable frame corner keys (4) See **Figure B.2**
- ✓ Pawl catcher See **Figure B.2**
- ✓ Water catch end caps See **Figure B.2**
- ✓ Euro-Covers (header and sill) See **Figure B.2**

Step B.2 - Panel Checklist

Each system comes with a number of panels allocated in the work order. Each door panel must be installed in the correct sequence, please refer to the installation drawing and panel labeling for the correct install sequence.

FIGURE B.1: SILL CONFIGURATIONS

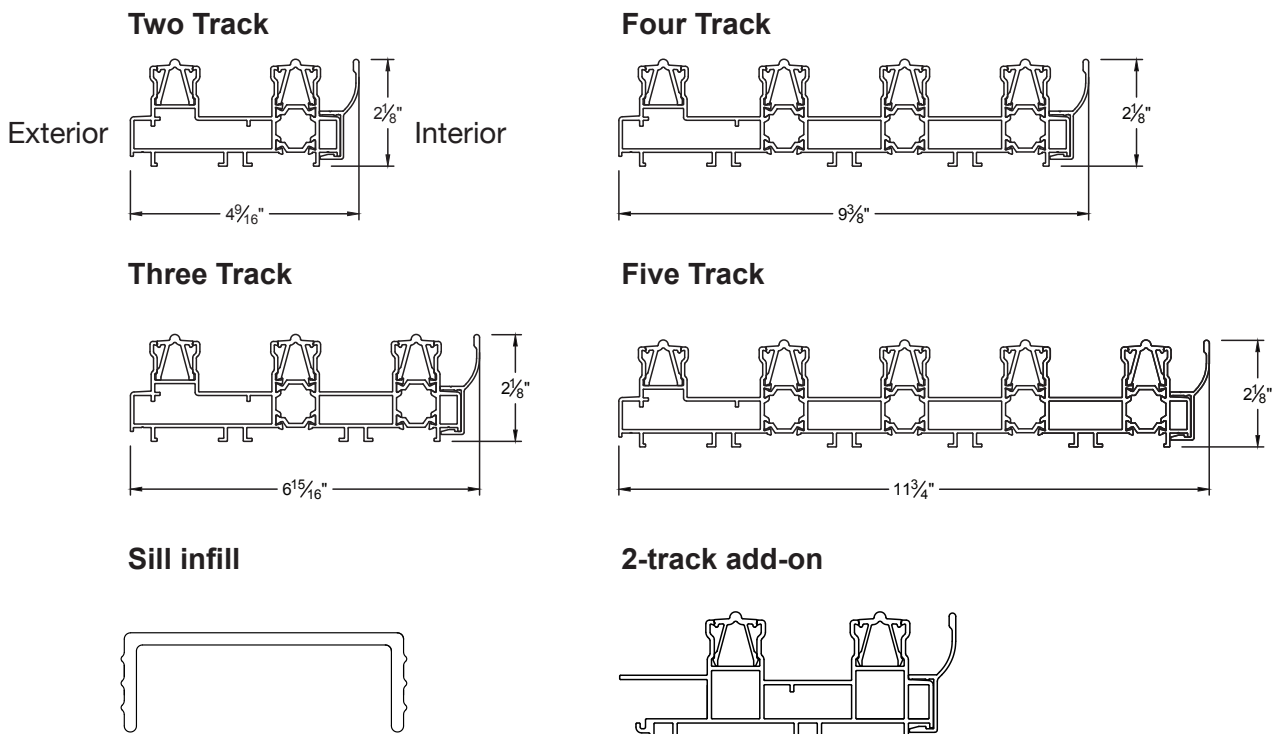
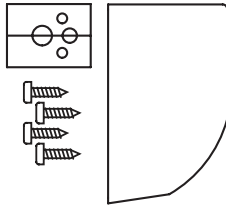
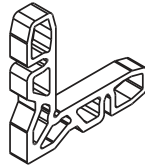

FIGURE B.2: HARDWARE CHECKLIST



03979
Panel Bumper



02922000
Corner Key

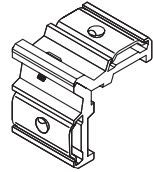

00336000
**Adjustable/Kamel
Corner Key**



62MP0500N
1/2" Hole Plugs



10N75UPP4
**Screw Used for:
Sill Drain Hole Cover,
Header Interlock Cover
and Water Catch**



8N50TPFS
Frame Screws

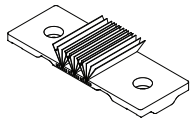

C0026-B
Upper/Lower Drain Hole Cover

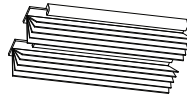

C0078-A_MS_WS_Hldr
**Corner Frame
Weatherstrip Holder**



Water Management Kit
Only provided if water management kit was ordered



02929000
Small Pawl Catcher

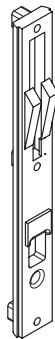

02897000
Large/Active Pawl Catcher

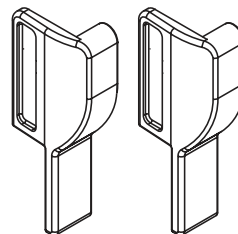

02938590
Water Catch End Caps

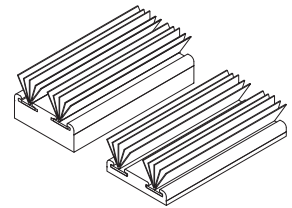

C0220-A/ C0178-B
**Astragal Gap Filler
Astragal Gap Filler Thin**

C. Opening Preparation

Step C.1 - Measure, Level, Square & Clean

- ✓ Measure opening at least 3 points (see **Figure C.1**) to check for plumb, square and level of the opening
- ✓ Vacuum / sweep opening to be clear of dust / dirt / debris
- ✓ Ensure that there is only a maximum header deflection of 3/16" or less

FIGURE C.1: MEASURING THE OPENING

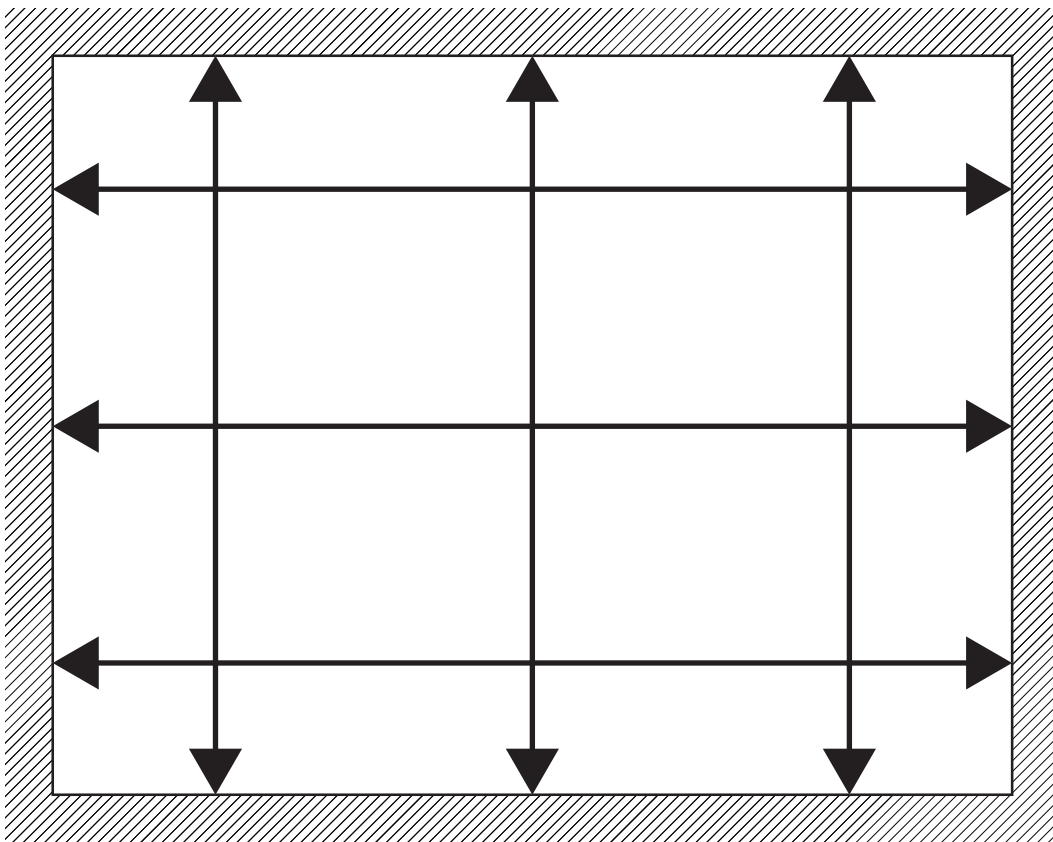

QR CODE: VIEW VIDEO INSTRUCTIONS ON MEASURING THE OPENING



Step C.1 - Measuring for Pocket Applications

When measuring for a pocket application you need to accommodate 2 1/4" in your pocket for the multi slide interlock to pass freely into the pocket. Additionally, you need to leave a 5/8" space on the opposite track side for clearance inside the pocket (see **Figure C.2** below).

FIGURE C.2: MEASURING FOR POCKET APPLICATIONS

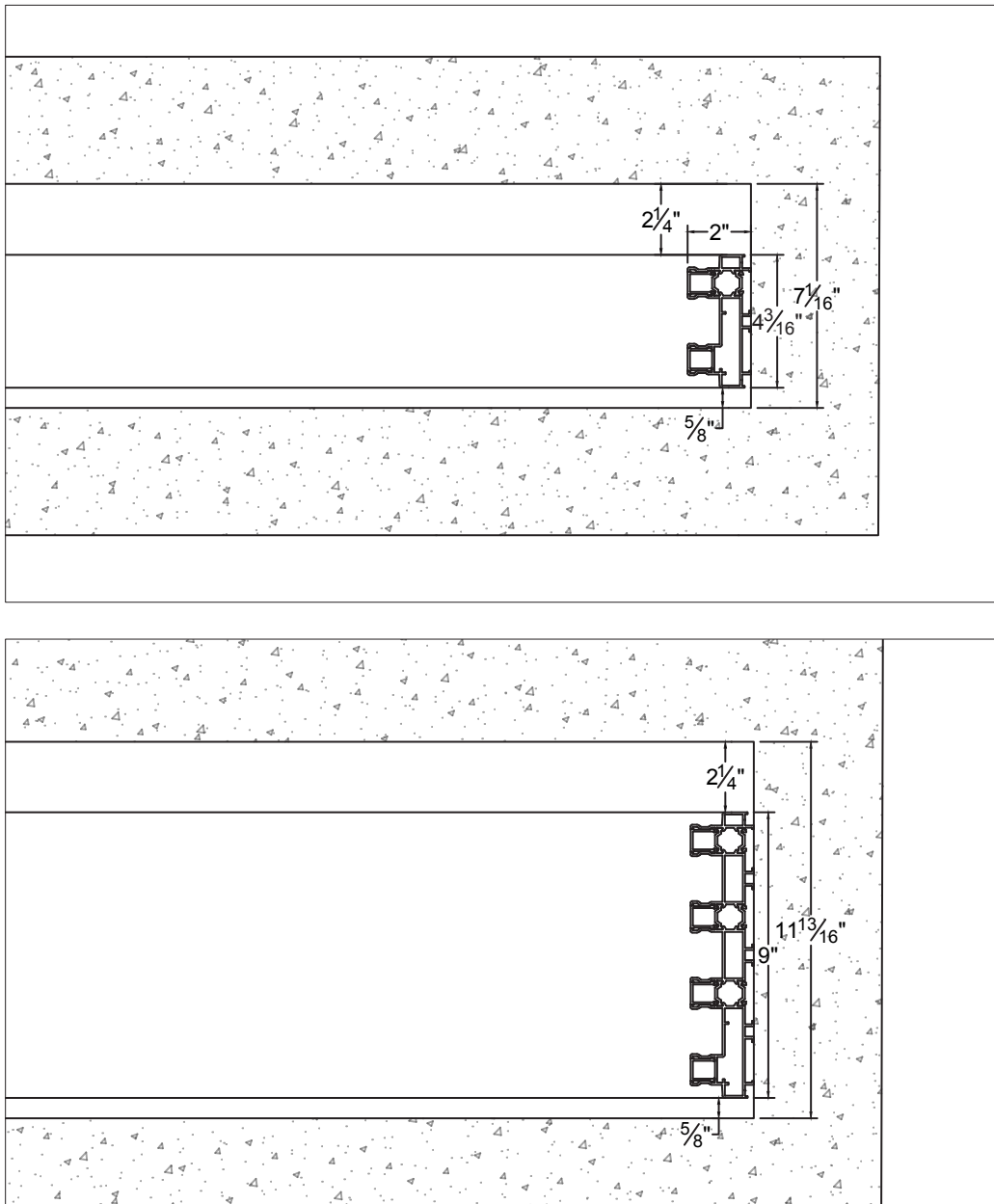

D. Embed Options **Figure D.1 - Embed Options Cross Sections**

Embed Options With Water Management

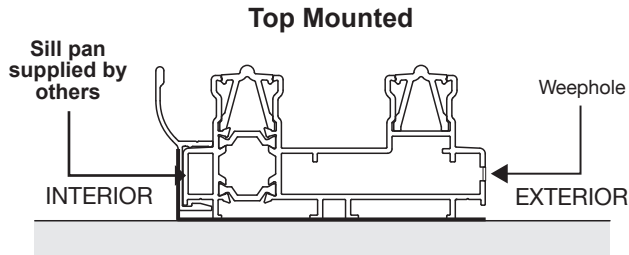

NOTE: Exterior slope recommended for any top mount or half embed condition.

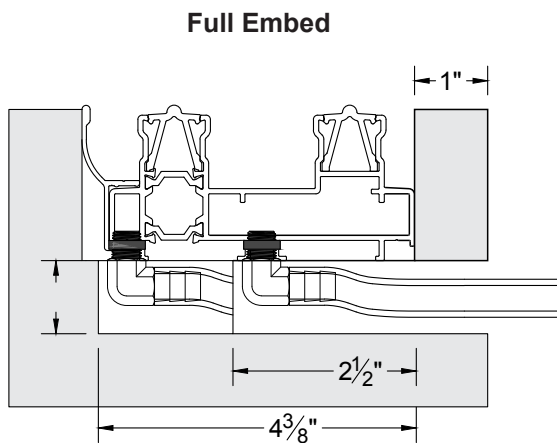
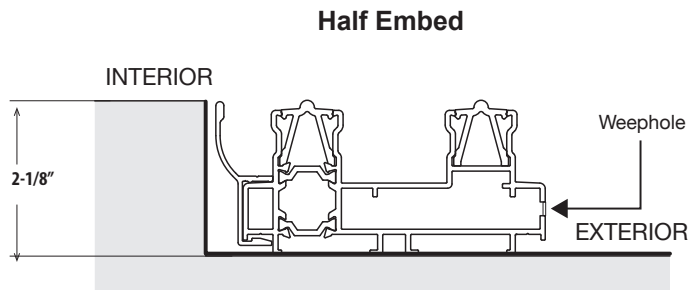

NOTE: Euro-Wall recommends using a sill pan for all door installations.

E. Frame Assembly

Step E.1 - Sealing the Frame

Fill and seal the opening of all chambers in the sill with 100% silicone. The number of chambers will vary and will be determined by the number of tracks for your particular project. Look down each chamber verifying they are completely filled with silicone and no daylight shows through the track.

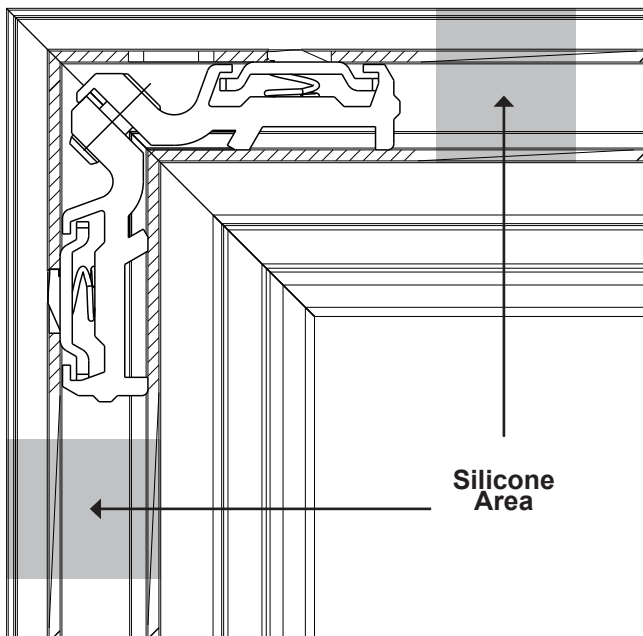

QR CODE:
SEALING THE FRAME



Step E.2 - Install the Frame Corner Keys and Attach the Jamb Tracks to the Sill Track

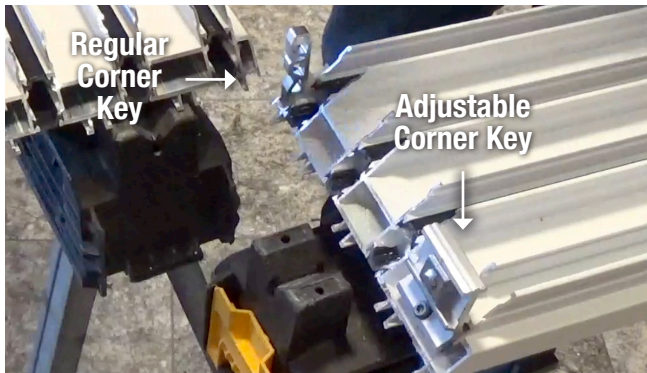

First, use a 4mm allen key and loosen the allen bolt on the adjustable corner key. This will make it easier to connect the jamb and sill tracks. Next, insert the adjustable corner key into the sill track into the largest chamber. Lastly, insert the fixed corner key on the opposite side of the adjustable corner key.

**QR CODE:
INSTALLING CORNER KEYS**

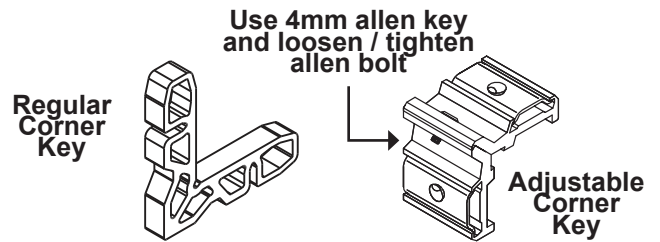

Make sure all of the chambers in the jamb track are sealed with silicon (reference step E.1) and connect the jamb track by sliding it over top of the sill track's corner key(s). Repeat process for both jambs. Add sealant to miter.

QR CODE: INSTALLING JAMB TRACK INTO SILL TRACK



Use a 4mm allen key to tighten the adjustable corner keys on both sides of the frame. Seal the corner joint holes with 100% silicone.



Secure the four corner keys on each side of the frame with screws. Dip screws.

**QR CODE:
SECURING CORNER KEYS**



Step E.3 - Install the Water Catch

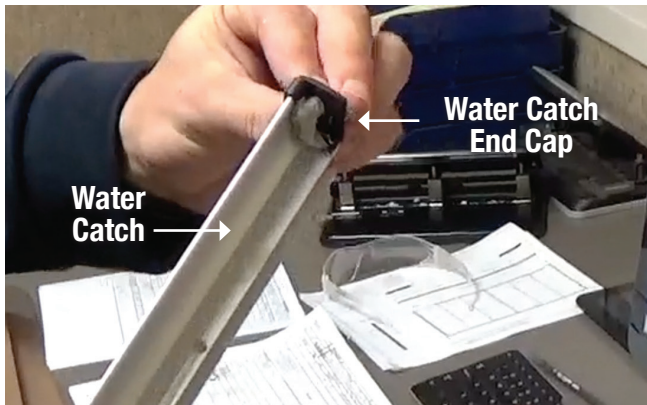

Place a bead of 100% silicone along the inside edges of the water catch end caps. Snap in place on both ends of the sill and header water catches. Smooth excess silicone where the water catch end cap and the water catch meet creating a water tight seal.

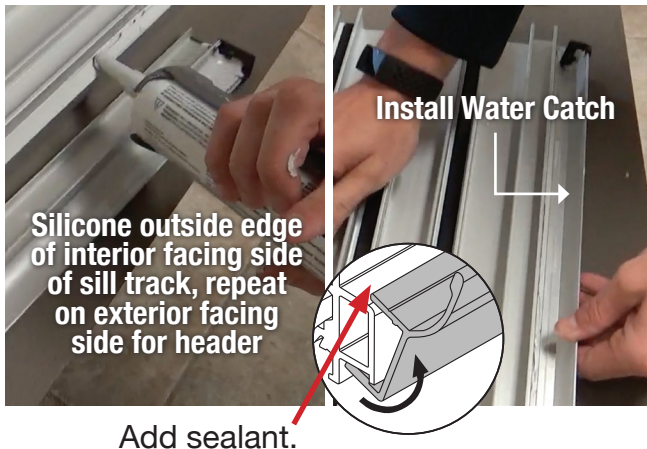
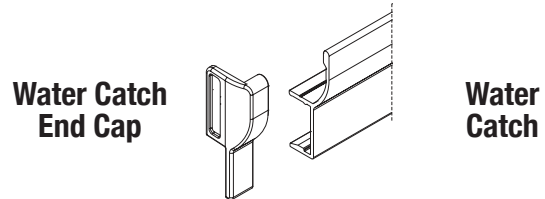

Place a bead of 100% silicone along the outside flat edge of the interior facing side of the sill track and outside flat edge of the exterior facing side of the header track. The water catch then snaps to the **interior facing side of the sill track** and on the **exterior facing side of the header track**. After snapped into place, run a bead of 100% silicone across the water catch and sill / header track seam. Next, pre-drill every 2 feet along the water catch and use self tapping screws to anchor into position.



QR CODE: INSTALL WATER CATCH



F. Dry Fit Frame

Step F.1 - Fit and Tack Frame into Place

Make sure opening is clean and clear of dirt / debris. Move frame into opening verifying opening is large enough. With the frame in position, temporarily tack into place through the jambs. All anchor screw locations on the frame come pre-drilled.

QR CODE: DRY FIT FRAME PROCESS



Step F.2 - Level & Plumb Frame

Check sill for level and plumb, shim where necessary. There should be no more than 1/16" sill sag at the center span of the sill. There should be no bow in the sill at any location.



Step F.3 - Pre-Drill Opening Substrate

Once the frame is shimmed and leveled, prepare the substrate by drilling through all frame anchor screw locations into the opening substrate where necessary. The type of drill bit used will vary depending on the substrate. Remove frame and vacuum / sweep clean debris.



G. Install the Frame

Step G.1 - Sealing Sill Track Opening

Make sure opening is clean of all dirt and debris. Seal sill track opening location with DOW 795 or 100% silicone. Place frame into opening and embed entire sill track into the sealant.



QR CODE:
SEALING THE SILL OPENING



NOTE: All frame anchor screw locations are pre-drilled

Step G.2 - Securing the Sill Track

Position frame so that the jamb is plumb and level with adequate space for shimming and then tack into place with screws. Repeat for the second jamb. Proceed to securing the sill track. Level the sill track placing shims at least at every other pre-drilled anchor screw location and anywhere else shimming is needed. **Make sure to use hex head anchor screws only when securing the sill.** Dip screws in silicone and secure sill at every anchor screw location. Ensure that the sill remains level after every anchor location is secured and adjust as necessary.

After sill is leveled and secured into position, place screw caps into the anchor holes.

IMPORTANT! Do not let an excess amount of silicone get into anchor holes. Water needs to travel freely through the track chambers. Do not over tighten screws as this could cause the frame to bow or damage the thermal break, which could lead to leaking.

QR CODE: SECURING THE SILL TRACK



Step G.3 - Securing the Jamb Tracks

Re-check jambs for level and plumb and secure jamb into place with screws. Do not over tighten screws as this could cause the frame to bow. After screwing the jambs securely into the opening, check again for level and plumb.



Step G.4 - Securing the Header Track

Starting at either of the jambs, shim and secure the header into place proceeding down the entire length of the header checking for level with a two foot level. Take care not to over tighten screws. After header is secured, re-verify level with a four foot level across the entire length of the header.



Step G.5 (If Using 2-Track Extension) - Securing the 2-Track Extension

Apply sealant to the lower groove of the 2-track extension, and the upper lip of the main track. Hook the 2-track into the groove on the bottom of the main track and rotate into place. Ensure that the groove is correctly interfaced to the main track, and ensure good sealant coverage.

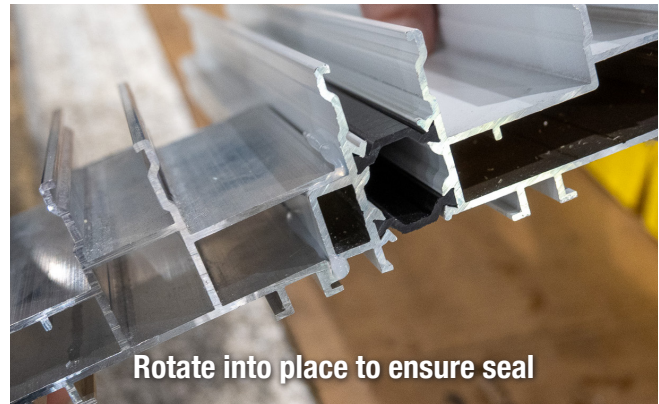
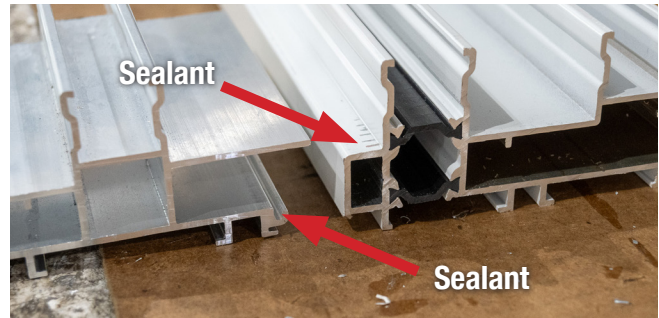

H. Install the Drain Cover

Step H.1 - Identifying the Drain Hold Cover

You will need to install the Drain Hole Cover **at every panel interlock**. See **Figure H.1** below to identify the drain hole cover and understand how it functions.

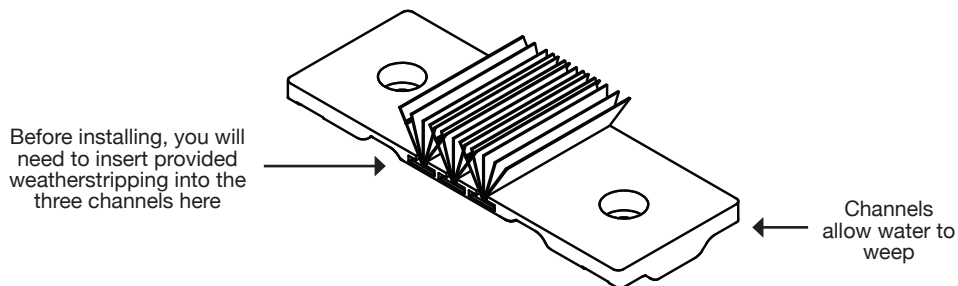

Step H.2 - Installing the Drain Hole Cover in Sill



Locate the pre-routed drainage holes in the sill track located at every panel interlock then apply silicone in the space between both holes creating a seal. You may need to shape the silicone with your fingers in order to create the seal between the two holes.



Apply the supplied weatherstripping to the drain hole cover.



Insert the drain hole cover into the sill track covering routed sill holes.



Secure the drain hole cover with self-tapping screws.

QR CODE: INSTALL THE DRAIN COVER



Step H.3 - Installing the Drain Hole Cover in Header

Follow the same steps as described in H.2 for installing the drain hole cover in the sill, minus one exception: **It is not necessary to apply silicone between the header cavity holes as there are no cavity holes.** However, you must still apply a silicone bed for the drain hole cover to sit on.

I. Install the Polyamide (Header and Sill)

Step I.1 - Install the Sill Snap Track

NOTE: It is important to note that you must not install the Snap Track until all anchor screws have been secured at all frame track locations.

NOTE: DO NOT INSTALL the Jamb Trim at this point in the installation.

Measure and cut your Snap Track to length. Starting at either jamb side, push one end of the Snap Track into the sill track until it snaps snugly into place. Slide the Snap Track all the way to the jamb on either side of the frame. You may now continue to push the rest of the Snap Track into the sill track by hand or with a rubber mallet.



Snap Track Profile

Step I.2 - Install the Header Trim

To install the Header Jamb Trim into the header, follow the same instructions used for installing the Snap Track listed above.



Header Trim

J. Water Management

Step J.1 - Horizontal Weepholes

For systems that do not have sufficient overhang and require a water rating where the track is either half embedded or a top mounted (**not fully embedded**) - please follow the instructions below.

Use a 5/16" drill bit and drill through the face of all the tracks up until, **and not through**, the track that contains a panel when the door system is closed (See Figure J.1 and J.2). Drill 3 holes evenly spaced along each panel section. See Figure J.2 for drill hole schedule / location.

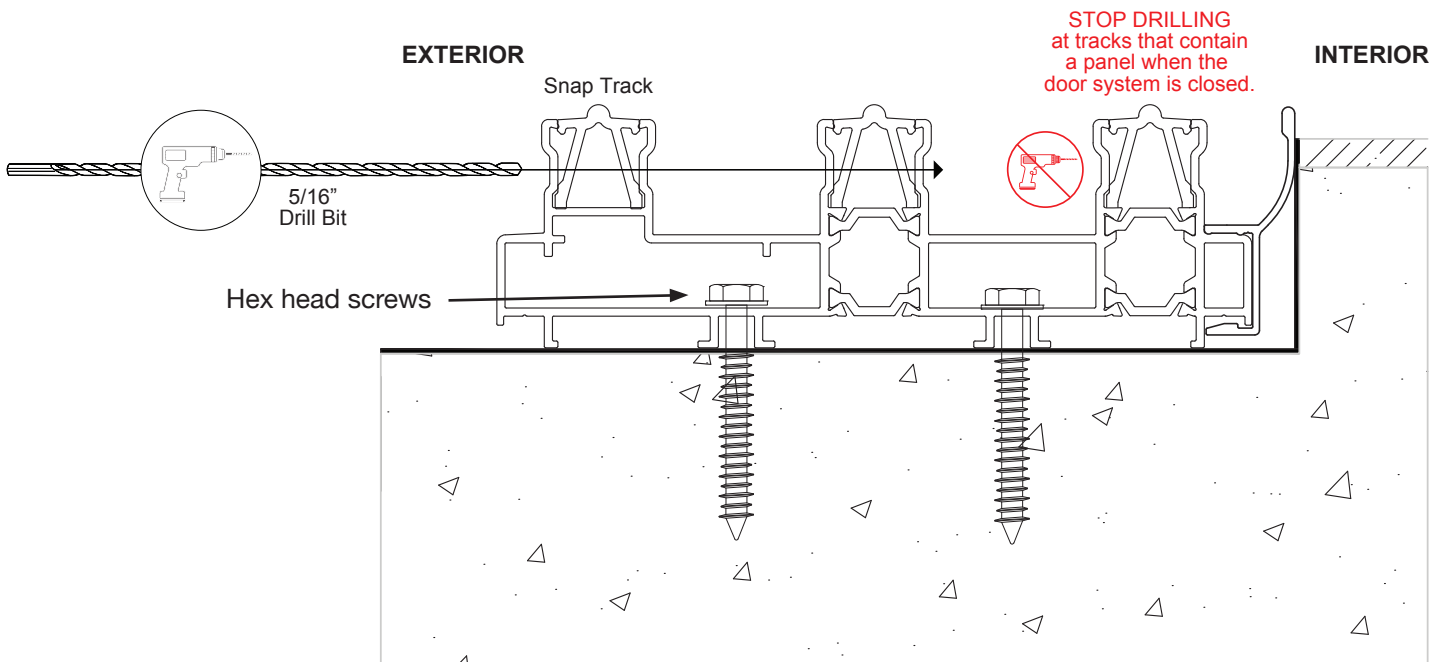

Figure J.1 - Cross Section View

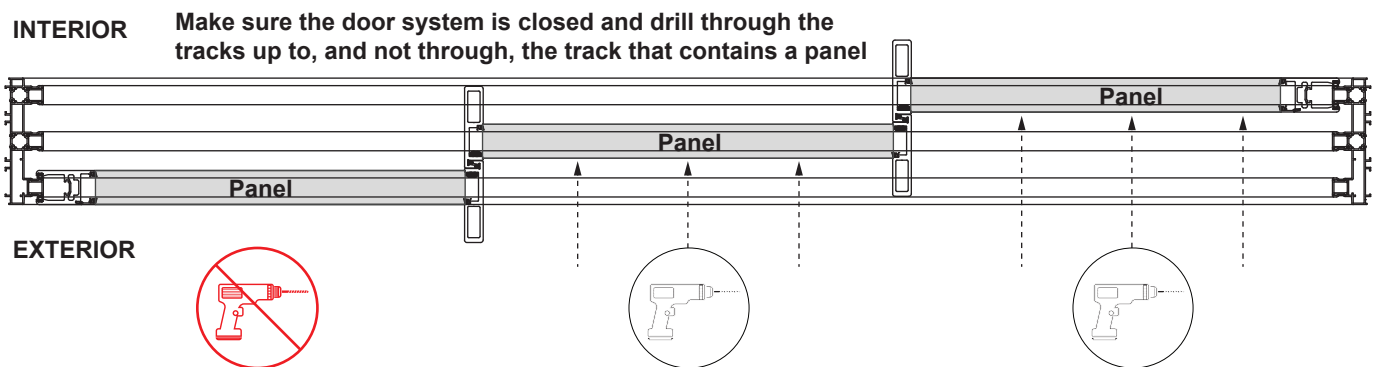

Figure J.2 - Top Down View

Step J.2 - Vertical Weepholes

Using a 5/16" drill bit, drill 2 holes, top down, through the water catch and into the last track chamber (track closest to the interior side of the opening). When you feel the resistance from the drill bit free up, you have successfully drilled through the water catch and track and into the track chamber. Make sure to STOP drilling at this point taking care to NOT drill through the bottom of the chamber (See Figure J.3).

Drill the first hole 12" away from the jamb, and the second hole 4" away from the first hole. For drill hole schedule / location, see Figure J.4.

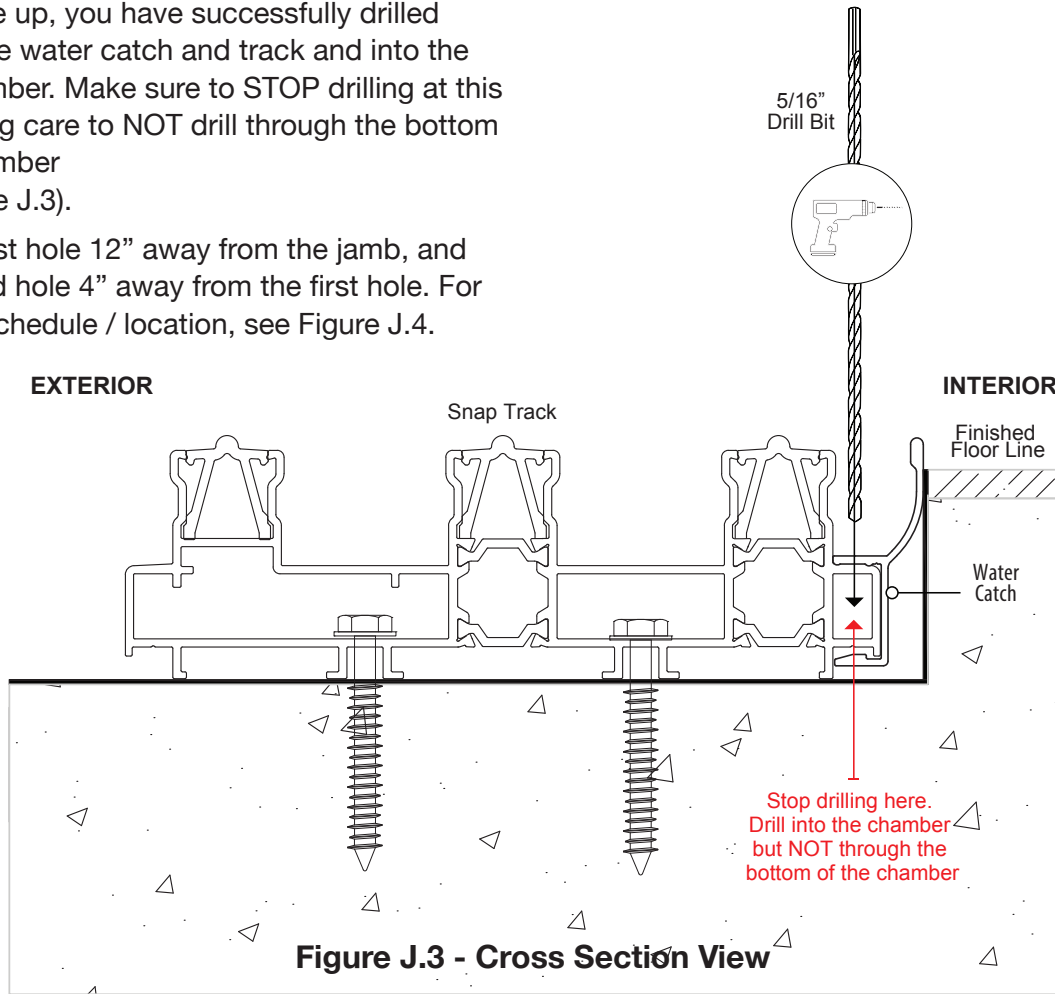

Figure J.3 - Cross Section View

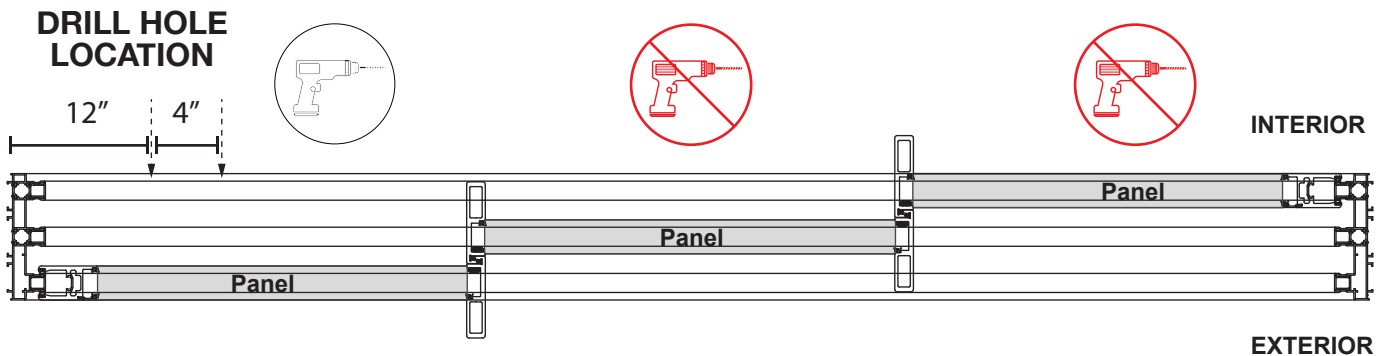
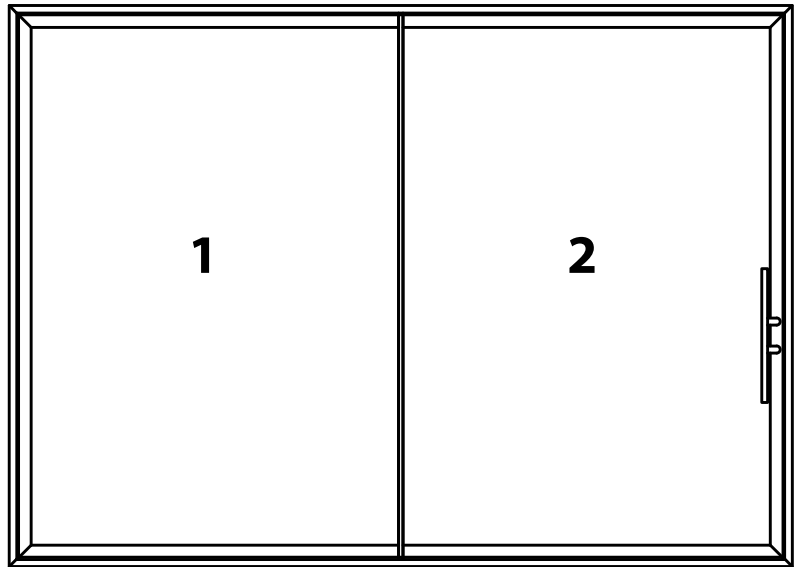

Figure J.4 - Top Down View

K. Install the Panels

Step K.1 - Check Panel Install Sequence

Included with the installation material will be a document that illustrates the panel install order with each panel numerically labeled.



Step K.2 - Panel Installation Preparation

Before installing panels, place wood, protective foam, cardboard or other similar protectant over the sill to protect from damage during the panel installation process. Additionally, have a ladder near the panel installation for ease of installation.

Each door panel comes with its own clearly labeled box which includes all hardware for that particular panel. Locate those and set aside. Move the first panel into position for install. When moving panels, always move them with at least two people making sure to **NEVER walk the panels**. Walking panels could knock the panel out of square. Use cup suction lifters for easier mobility when moving larger panels.

QR CODE:
PREPARING FOR
PANEL INSTALL



Incorrect

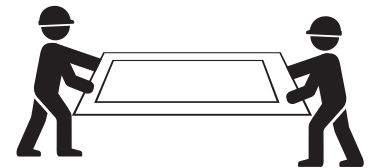

Correct

QR CODE: DON'T
"WALK" PANELS



Step K.3 - Install Panels

Angle the panel with the top of the panel facing forward towards the opening. **1)** Lift and insert the header sash into the header track then **2)** swing the bottom sash into the opening and onto the bottom sill track.

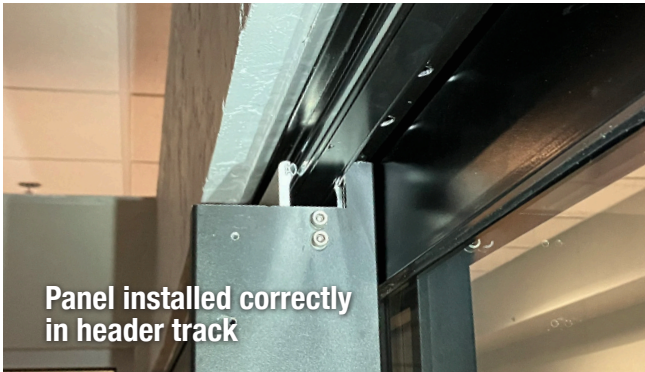
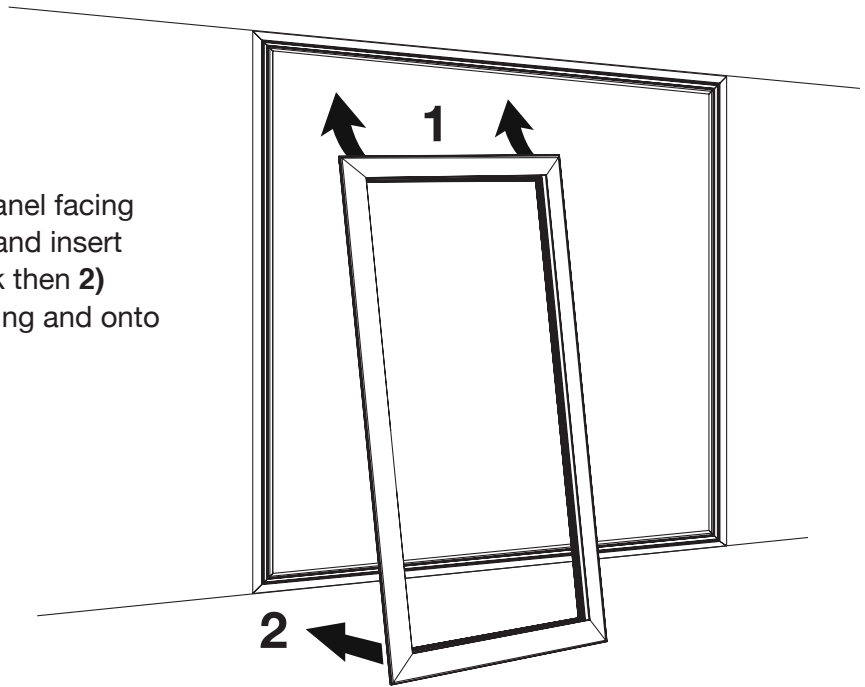

QR CODE: INSTALL THE PANELS



L. Install Pawls, Catches & Jamb Flat Snap Track

Step L.1 - Find Locations & Prepare Pawl Catches

First, locate the pawls that are pre-installed in the panel sashes. Next, locate the pawl catches located with the hardware box designated for the panel you are working on. Use a 2.5mm allen key and loosen the allen set screws on the pawl catches - preparing them for installation.

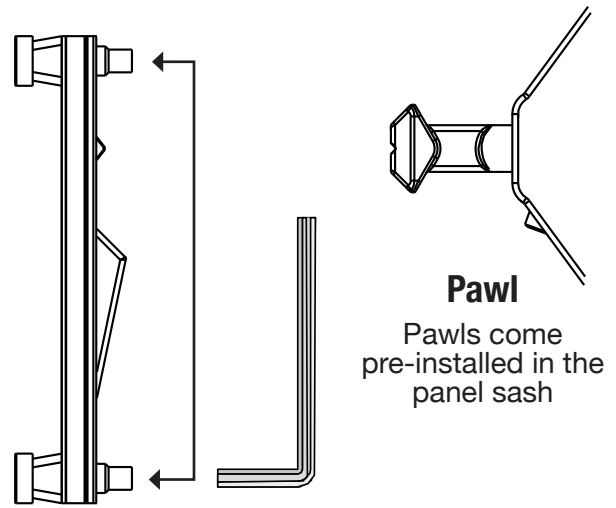

Pawl Catch

Pawl

Pawls come pre-installed in the panel sash

Loosen the allen set screws on the catches before installation with a 2.5mm allen key

Step L.2 - Mark Catch Install Location

Snap the pawl catch into the jamb track. Bring the opposite panel over. Identify where the center of the pawl is in relation to the opposite panel. Mark the location on the pawl catch track with a pencil.

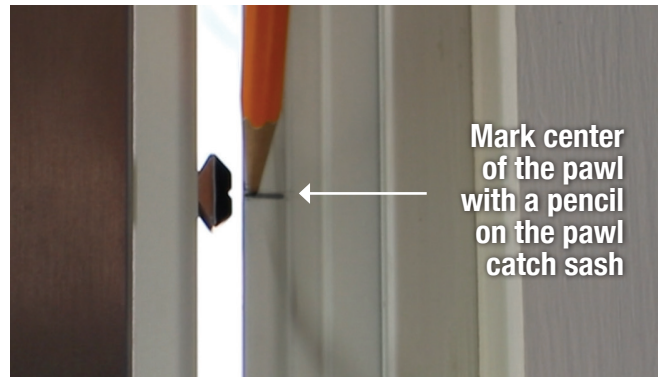

Mark center of the pawl with a pencil on the pawl catch sash

QR CODE: MARKING PAWL INSTALL LOCATION



Step L.3 - Install Catcher / Adjustments

Return panels to open position. The pawl catcher has an identifying ridge denoting the install position. Raise the pawl catcher up and even with the marked location and tighten the allen set screws on the pawl catcher with a 2.5mm allen key. Slowly bring over the opposite panel and close the door. Engage the twin point lock. If the pawls do not securely engage with the catchers, **you will need to loosen the pawl set screw and rotate the pawl to lengthen or shorten the pawl reach to ensure proper closure** (See figure L.3).

When properly installed the twinpoint will engage the pawl into the pawl catcher securing the door system. Clean off your pencil mark location. **Repeat previous steps for all pawl locations.**

**QR CODE:
INSTALLING THE PAWLS**

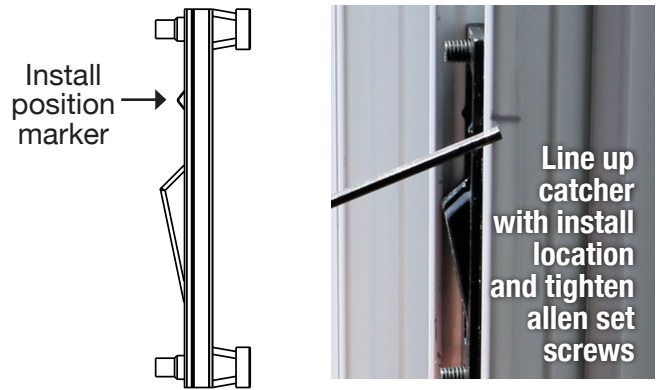
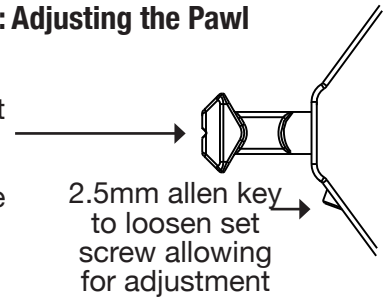

Figure L.3: Adjusting the Pawl

Loosen the allen set screw and rotate the pawl clockwise or counterclockwise to shorten or lengthen to make adjustments



Step L.4 - Install Flat Snap Track

Measure the distance for each gap between the pawl catchers and cut your flat snap track to fit. Starting at one end, push into sash and snap the track into place the entire length using your hand or a rubber mallet. Repeat for each pawl catcher gap.



**QR CODE: INSTALLING PAWL
CATCHER TRIM PIECES**

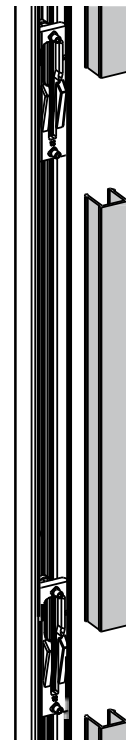

M. Pocket Applications

Step M.1 - Pocket Installation

For pocket applications a supplied P Hook (see figure M.1) is secured to the pocket. When the first pocket side panel is parked inside of the pocket it secures and interlocks with the P Hook creating a stopping point for the door system.

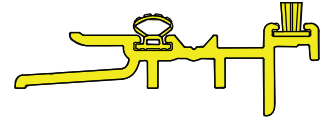
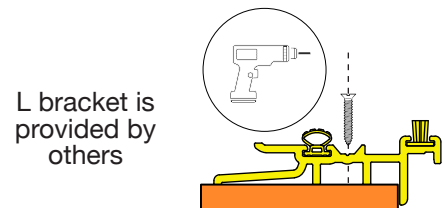

Figure M.1: P Hook - Profile View

Step M.2 - Secure P Hook

You will need to use a supporting 4" x 2" aluminum L bracket that is roughly 1/4" thick and runs the full height of the P Hook. Secure the P Hook to the aluminum L bracket using an appropriate length screw at the location marked in figure M.5. Ensure the screw does not protrude through the L bracket - if it does you will need to grind flush.



Aluminum L bracket
4" x 2" x 1/4" thick

Figure M.5: Aluminum L Bracket

Step M.3 - L Bracket Placement

Fully close the door system
(See figure M.6)

Slide the P Hook and L bracket behind the panel interlock and adjust until the P Hook fits snugly with the panel interlock
(See figure M.7).

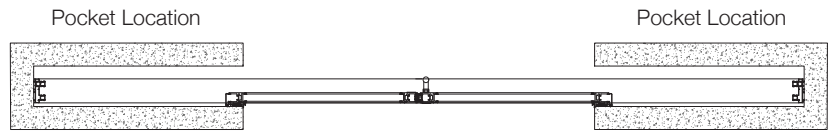

Figure M.6: Fully Close and Secure Panels

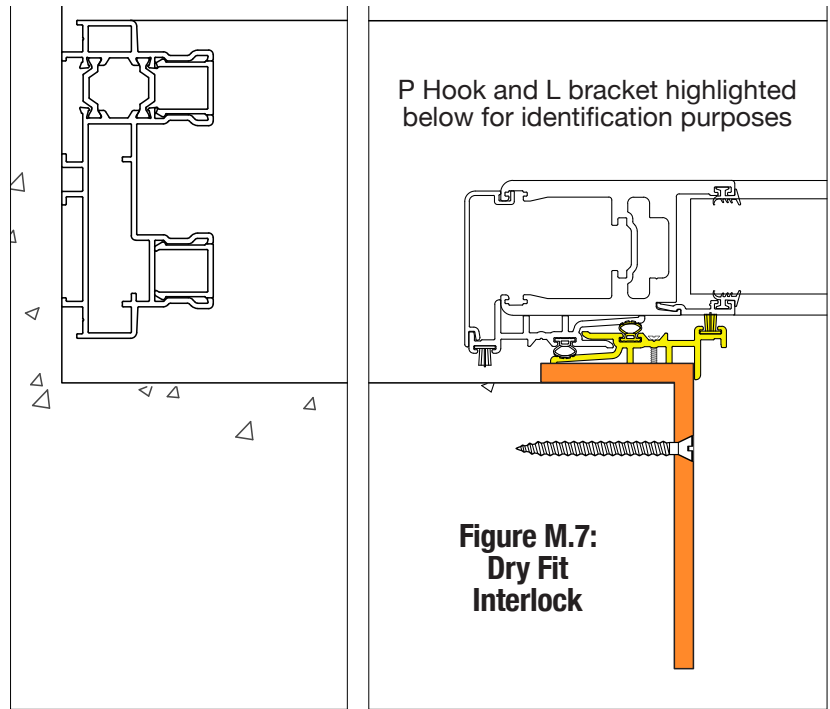

Figure M.7:
Dry Fit
Interlock

Step M.4 - Secure L Bracket / P Hook

Secure the L bracket to the pocket at the marked location in Figure M.8 with flat head screws. The screw type and size used will vary depending on your substrate conditions and are not provided by Euro-Wall.

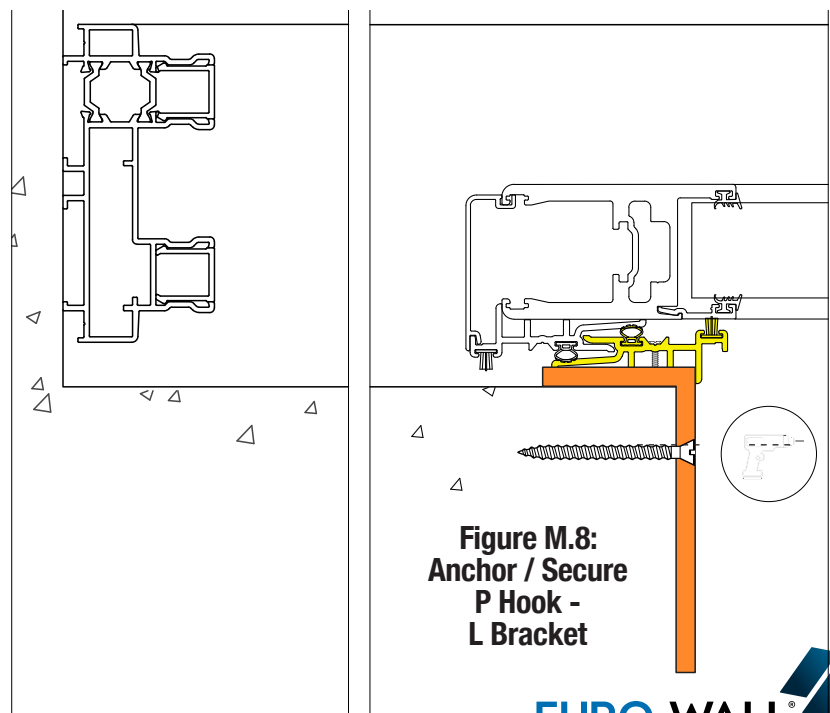

Figure M.8:
Anchor / Secure
P Hook -
L Bracket

N. Adjusting the Panels

A Note About Making Adjustments

There are two adjustments that can be made to panels to ensure proper closure of your system: 1) pawl adjustments and 2) roller adjustments. (See page 21, step L.3 for making pawl adjustments). The panel rollers of your door system are factory set to work precisely with your installation. Therefore, adjusting the pawls should ensure proper closure of your door system in almost every situation.

Roller adjustments should ONLY be made as a last option and is not recommended.

Depending on the completion date of your project, your multi slide panel will have one of the following scenarios. Follow the step for whichever scenario your project has:

Step N.1 - Making Vertical Adjustments

Prior to April 2021

At the base of all interlock stiles you will see two screws. To make vertical adjustments, remove the bottom screw **ONLY**. **If you remove the top screw, you will cause a complete panel failure.** After the bottom screw is removed at the interlock, insert a #6 allen wrench into the screw hole and rotate clockwise or counterclockwise to raise or lower the panel.



Step N.2 - Making Vertical Adjustments

April 2021 or Newer

At the base of all interlock stiles you will see two screws and a 1/2" hole. To make vertical adjustments, remove the 1/2" hole plug. After the 1/2" hole plug is removed at the interlock, insert a #6 allen wrench into the hole and rotate clockwise or counterclockwise to raise or lower the panel.

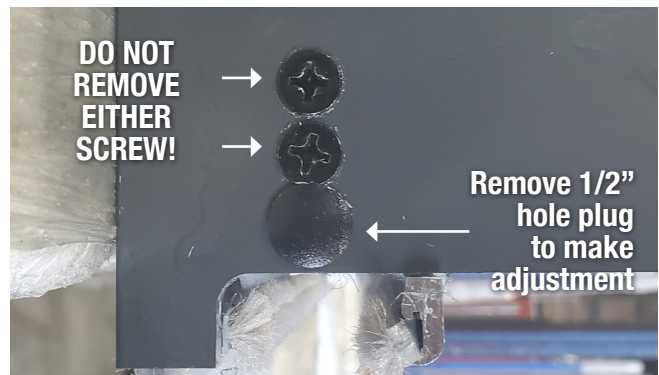

NOTE: Each roller adjustment **ONLY** lowers or raises that end of the panel. To ensure your panel rolls smoothly and evenly in the track the opposite panel roller will need to be adjusted in the same increment as the first adjusted roller. **Additionally**, each panel in the system will need to have both rollers adjusted in the same increment to ensure the interlocks catch and grab correctly.

O. Locking Fixed Panel

Step O.1 - Locking Down Fixed Mechanism

Line fixed mechanism up with adjustment hole. Flathead screw driver (or provided removable twinpoint) must be able to fit in. Insert flathead screwdriver (or provided removable twinpoint) into adjustment hole and turn the locking mechanism to lock in place. If the mechanism is difficult to engage, there are horizontal adjustments that can be made to pawls in the stile. Whether in or out, adjust until operation is smooth.

After locking the panel down, place a 1/2" hole plug into the hole to seal it.



P. Door Bumper Installation

Step P.1 - Door Bumper Install

Do not begin this step until all adjustments have been made to the door. The door bumper kit will include a bumper, a mounting bracket and three screws. Use at least two screws when mounting bracket. Bumper should be mounted on the panel adjacent to the primary active panel. Bumper is typically installed on the interior side, but can be installed on the exterior side. Bumper can be installed on the top or bottom of this panel. Use the handle of the operational panel to indicate placement of the bumper. Open the panel until there's a 1/4" reveal on your daylight opening of the adjacent panel. Drill two or three holes (depending on how many screws used) with a #21 drill bit and tap with a 10-32. When mounting the bracket, countersunk holes should be facing outward. Mount bracket onto where holes are drilled. Slide the groove of the bumper onto the bracket. *(continued on next page)*



Please note: If the pull bar is an offset pull bar, spacing of bumper will need to increase to avoid hand on the pull bar hitting the adjacent panel.

**QR CODE:
INSTALLING THE DOOR
BUMPER**



Q. Recessed Pull Transport Screw Removal

Step Q.1 - Remove the Screw

Once the panels are installed, remove any shipping screws from the bottom of the recessed pulls.



R. Postless Corner Weatherstrip Installs

Step R.1 - Frame Weatherstrip Holder

Snap up the frame weatherstrip holder into the header track of the non-astragal panel at the corner connection. Slide the holder all the way to the corner of the header.

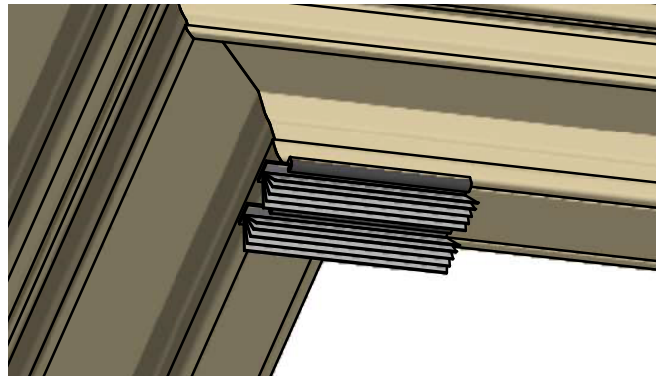

Step R.2 - Astragal Weatherstrip Holder

Snap the astragal weatherstrip holder into the astragal and slide down until it hits the condensation drain. Above the astragal weatherstrip holder you will be infilling this space with jamb trim.

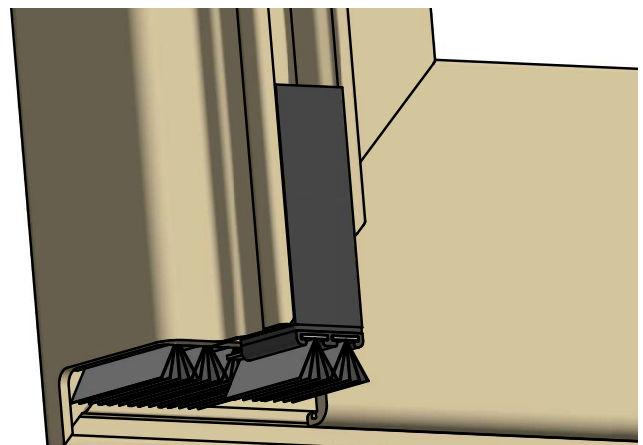

S. Astragal Gap Filler

Step S.1 - Apply Gap Filler

If you have a center meet configuration, apply the astragal gap filler on the panel with the astragal. There will be 2 different sizes in your hardware box. Based on your final adjustments, apply the appropriate sized gap filler.

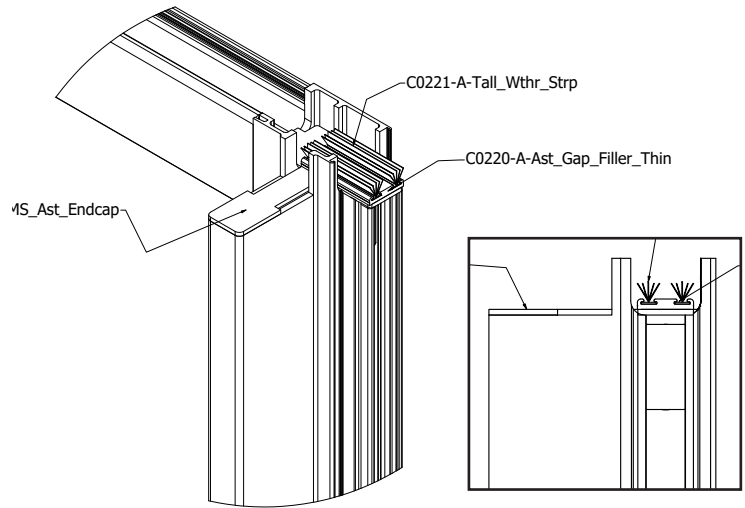

T. Optional Water Management System Installation

Required Tools

- ✓ Channel locks
- ✓ 100% silicone
- ✓ Caulk gun



1 Screw the brass hex nut onto the brass hose barb, securing tightly.



2 Silicone the exposed threading on the brass hose barb making sure not to obstruct the opening.

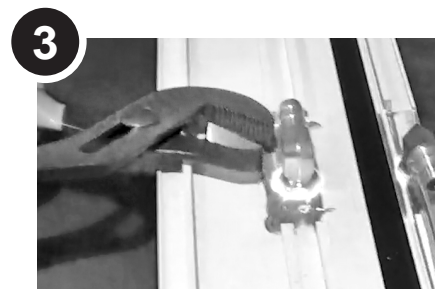

3 Install the brass hose barb onto the bottom side of the sill track - secure tightly with channel locks.

QR CODE:
WATER MANAGEMENT
INSTALLATION



U. Maintenance & Care

Panel Protective Film

If your project comes with protective film, remove all protective film from panels, frames and any other metal extrusion within 30 days of job delivery. Failure to do so could cause finish damage voiding the product warranty.

Handles and Hardware

Wipe down the visible surfaces with warm soapy water on a soft cloth and then rinse off by wiping with a clean damp cloth. Spray a thin film of light machine oil or one of the corrosion preventative sprays such as CRC Marine 66®, Innox® or CorrosionX®. Be careful to avoid overspray and be sure to wipe down any overspray that does occur.

Water Management

If your sill track comes with a Euro-Wall water management configuration, ensure that all drainage points are free and clear of debris.

Sill Track and Wheels

Wipe all contaminant clear from sill track surfaces with a damp cloth and mild detergent, dry with clean soft cloth. Using a spray machine oil or one of the corrosion preventative sprays (such as, CRC Marine 66®, Innox® or CorrosionX®) spray underneath the panels and into the wheel assembly. Operate the door

across the sill track to ensure the track receives lubrication / anti corrosion spray from the wheels. Repeat as necessary until the wheels and the track is properly covered. Wipe down any overspray.

Frequency

Regular maintenance is required for all hardware, even stainless steel, to keep manufacturer's warranty in place. Failure to provide proof of maintenance will void any warranty.

Carry out maintenance procedures with the following minimum recommendations:

- General environments - every 3 months
- Marine, industrial environments, within 5 miles of a body of water and / or a pool area - every month.

NOTE: Maintenance is required to extend the life of your door system and to maintain the Euro-Wall Warranty

VIDEO RESOURCE LIBRARY

**Ladder Pull
Handle Install**

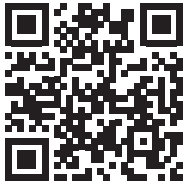

**Replacing
Recessed Pull
Handle**



**Twinpoint
Lever Install**



**Fix Snapped
Polyamide**



**How to Remove
Snap Bead**



**Internal
Mechanism
Adjustments**



**Corner
Connection
Adjustment**



**Lock Fixed
Panel**



**Anti-Slam
Adjustment**

